

AC POWER UNITS
DC POWER UNITS
PICK-A-PACK PRODUCTS

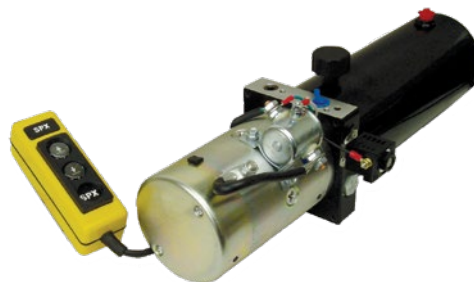

Wide Range of Configured Hydraulic Power
Units & Component Kits for Industry

THE STONE HYDRAULIC ADVANTAGE

**Complete Versatility,
We Offer Four Distinct
Solutions To Best Fit
Your Needs & Market
Application.**

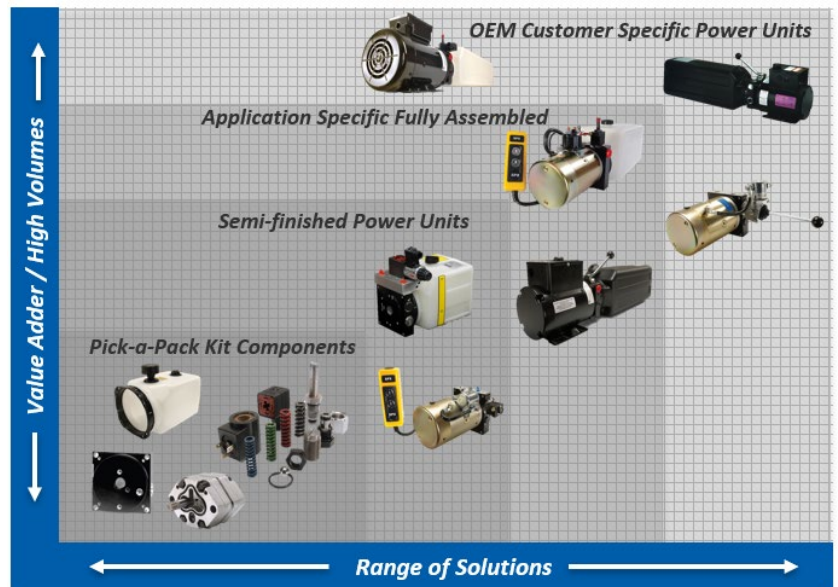

MODULAR HIGH QUALITY AC & DC HYDRAULIC POWER

Motors offer unique benefits to the market. AC and DC versions are available in a wide range of voltages and duty cycles. Each motor is equipped with a spine shaft to increase connection point durability. (DC Motor Shown)

Valves are available in solenoid or manual actuation. Industry standard cartridge valves ensure system versatility.

Reservoirs are available in steel or plastic configurations with capacities from 3 Qt to 14 gallon.

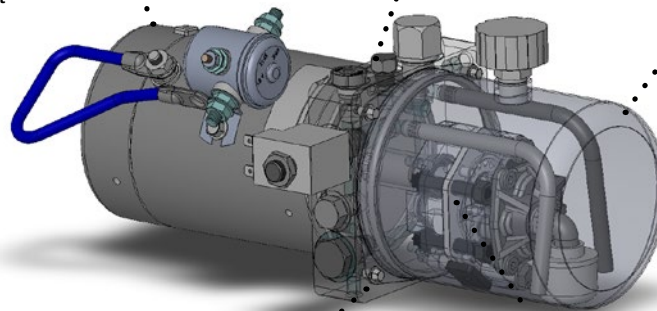

Universal End Head design's offers easy adaptability for most combination pumps, motor, reservoir, and valve assemblies.

Gear pumps are equipped with 13-tooth gears that have precision fixed clearances. Designed with hardened and ground sintered gears in high tensile strength housings.

FACTORY ASSEMBLED UNITS

DC UNITS SEMI-FINISHED (NO TANK)

- DC-10SF** 12V DC Manual Operated Power Up/Gravity Down
- DC-20SF** 12V DC Solenoid Operating Power Up/Gravity Down
- DC-30SF** 12V DC Check and Relief Valve Power Unit
- DC-60SFC** 12V DC Solenoid Operated Power Up/Power Down
- DC-90SF** 12V DC Relief Valve Only

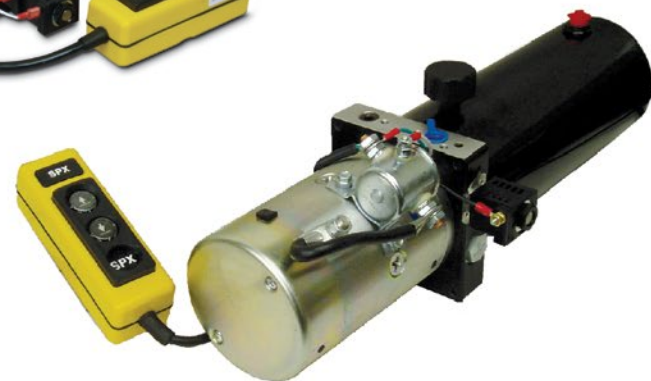
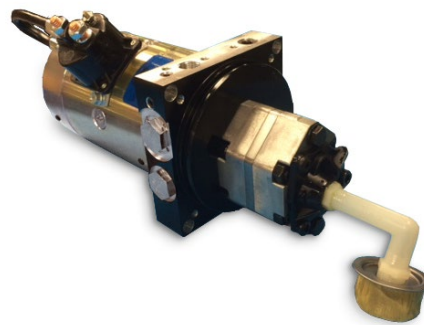

FACTORY ASSEMBLED UNITS

SPECIFIC APPLICATION UNITS

AC-10AH	230VAC 1PH Auto Hoist 2-Post Lift Power Up/Gravity Down
AC-10KS	230VAC 1PH Auto Hoist 2-Post Lift With Kill Switch Power Up/Gravity Down
AC-10FP-A	230VAC 1PH Auto Hoist 4-Post Lift Power Up/Gravity Down
AC-10TC	115VAC 1PH Tire Changer Power Up/Gravity Return
AC-40FC	115VAC 1PH Filter Crusher Power Extend/Gravity Return
DC-24MH	24VDC Material Handling Solenoid Operated Power Up/Gravity Down
DC-70BS	12VDC Bale Spike Solenoid Operated Power Up/Power Down
DC-80SPC	12VDC Snow Plow Solenoid Operated Power Angle & Lift/Gravity Down

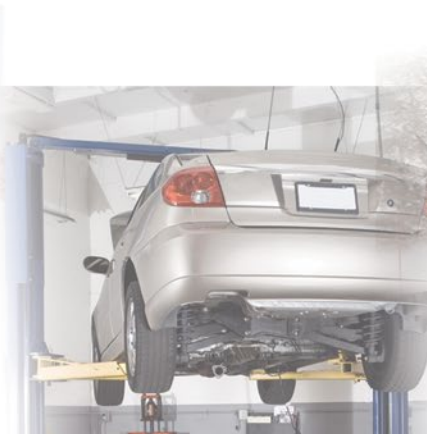
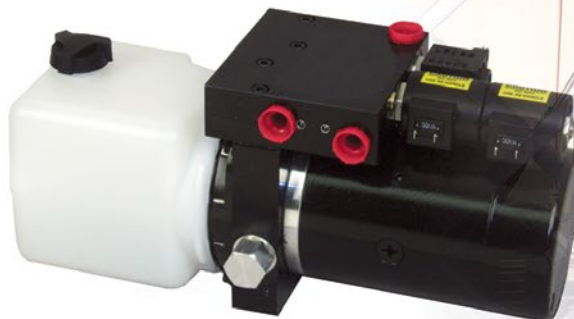

PICK-A-PACK INTRODUCTION

The Stone Pick-A-Pack product range is based on a system of modular construction which was pioneered by Stone Hydraulics when the company was founded in 1968. This concept and the components utilized have been continuously refined and improved through the years. Today, Stone applies the most advanced manufacturing technologies and the highest quality materials and components available to provide this unique and extremely flexible product range.

International Distributor Pick-A-Pack Product Range

This section is designed to aid the user in selecting a combination of pump, motor, reservoir, and valves which will precisely suit their needs.

All of the components in the Pick-A-Pack product range are designed to be interchangeable with mating components. All components are modular in design and the "International" endhead is the key component of this interchangeable system. Any desired combination of drive motor, pump, reservoir, and control valving can be either assembled into or manifolded onto this endhead. This is available in three configurations, with either NPTF or SAE porting.

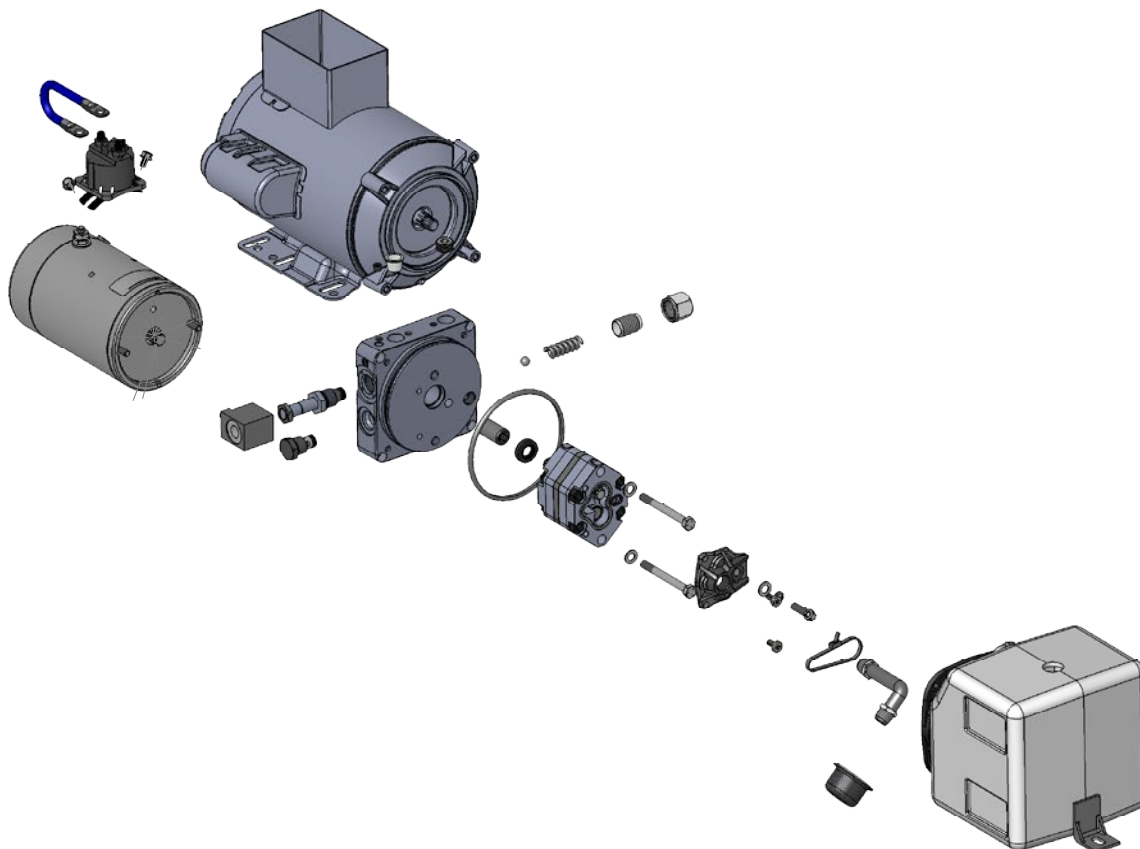

PICK - A - PACK PRODUCT RANGE

POWER UNIT ORDERING CODES

1 Select - Motor / Motor Adaptor

2 Select - Pump

3 Select - Endhead





4 Select - Integral Valve

5 Select - Reservoir

6 Select - Plumbing

0 Select - Manifold Valve

0 Select - Electrical Accessories

1	2	3
Motor / Motor Adaptor	Pump	Endhead
KM_ KMC KMD KMP	KP_ KU_	KN_
 3" DC Motors		
 4.5" DC Motors	 Pumps	 Metric Footmounts with SAE or BSPP Ports
 High Power DC Motors	 HI-LO Pumps	
 Nema C AC Motors Customer Supplied		 UNC Footmounts with SAE or NPT Ports
 AC Motors	 Unload Valve Assembly	
 Adaptors		

4 Integral Valving	5 6 Reservoir / Plumbing	Optional Manifold Valves	Optional Electrical Accessories
KC_ KFC_	KR_ KH KV	KB_ KDVC	KG_ KS_
 <p>Relief Valve-Only Kit</p>	 <p>Steel Reservoir 4.75" (120mm) Diameter</p>		
 <p>Relief and Check Valve Kit</p>	 <p>Steel Reservoir 6.7" (170mm) Offset</p>	 <p>D03 Cetop Valve Adapter</p>	
 <p>Relief, Check, Manual NC Valve Kit</p>	 <p>Plastic Reservoir 5.0" (127 mm) Square</p>		<p>Cord Set: Options</p> <ul style="list-style-type: none"> ▪ Power Up, Gravity Down ▪ Power Up, Power Down (1) Solenoid ▪ Power Up, Power Down (2) Solenoids
 <p>Relief, Check, 12VDC, 24VDC, 115VAC, 230VAC, Solenoid NC Valve Kit</p>	 <p>Plastic Reservoir 6.7" (170 mm) Offset</p>	 <p>Manifold Cartridge Valves</p>	
 <p>Flow Control</p>	 <p>Industrial Reservoir</p>  <p>Vertical Inlet Plumbing</p>  <p>Horizontal Inlet Plumbing</p>	 <p>Manifold Valve Blocks</p>	 <ul style="list-style-type: none"> ▪ 12 & 24VDC Start Solenoids

PICK - A - PACK PRODUCT RANGE

AC MOTORS

KMC16 1HP

3450 RPM, 1PH
115/230V 60HZ

KMC17 2HP

3450 RPM, 1PH
115/230V 60HZ

KMC18 3HP

3450 RPM, 3PH
230/460VAC 60HZ

KMC19 3HP

3450 RPM, 3PH
230/460V 60HZ

KMC20 5HP

3450 RPM, 3PH
230/460V 60HZ

KMC21 1/2 HP

1725 RPM, 1PH
115/230V

KMC22 1/2 HP

1725 RPM, 3PH
230/460V 60HZ

KMC23 1 HP

1725 RPM, 1PH
115/230V 60HZ

KMC24 1HP

1725 RPM, 3PH
230/460V 60HZ

ADAPTORS

KM96

182/184
NEMA CFACE

KM97

56/143/145
NEMA CFACE

DC MOTORS

KIT NUMBER	VOLTAGE	DUTY	UL RECOGNIZED
KM05	12 VDC	500W	YES
KM06	24 VDC	500W	YES
KM08	12 VDC	800W	YES
KMD1	12V	STANDARD	NO
KMD2	12V	STANDARD	YES
KMD3	12V	EXTENDED	NO
KMD4	24V	EXTENDED	NO
KMD5	24V	STANDARD	YES
KMD6	24V	STANDARD	NO

PICK - A - PACK PRODUCT RANGE

PUMPS

KIT NUMBER	DISPLACEMENT		LENGTH		MAX RPM	MAXIMUM PRESS	
	CC REV	CIPR	MM	INCH		CONT. PSI/BAR	INTERMIT PSI/BAR
KP08	0.8	0.049	57	2.25	5000	4000/350	5000/350
KP10	1.0	0.061	58	2.28	5000	4000/350	5000/350
KP12	1.2	0.073	59	2.32	5000	4000/350	5000/350
KP16	1.6	0.098	60	2.38	5000	4000/350	5000/350
KP20	2.0	0.122	62	2.44	4000	4000/350	5000/350
KP25	2.5	0.153	64	2.52	4000	4000/350	5000/350
KP31	3.1	0.189	67	2.62	4000	3600/250	5000/350
KP40	4.0	0.244	70	2.75	4000	3000/200	4000/280
KP50	5.0	0.305	74	2.90	4000	2300/160	3200/220
KP63	6.3	0.384	79	3.11	3200	1800/125	2500/175
KP80	8.0	0.488	86	3.37	2400	1500/100	2000/140

Kit includes washers and mounting bolts. Use all washers. Mounting bolts are grade 5.
DO NOT SUBSTITUTE. KP10 cannot be used in duplex pump applications.

ENDHEADS

KIT NUMBER	DESCRIPTION
KN09	ENDHEAD METRIC FOOTMOUNTS SAE PORTS
KN10	ENDHEAD METRIC FOOTMOUNTS BSPP PORTS
KN11	ENDHEAD UNC FOOTMOUNTS NPT PORTS
KN12	ENDHEAD UNC FOOTMOUNTS SAE PORTS

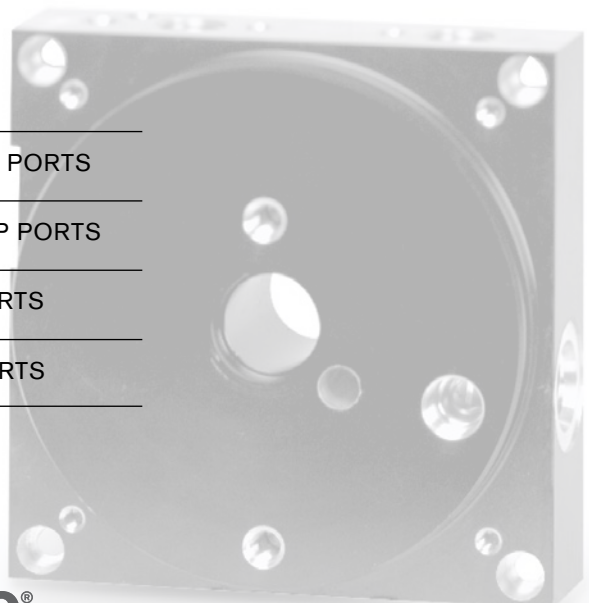

PICK - A - PACK PRODUCT RANGE

INTEGRAL VALVES

KIT#	DESCRIPTION	KIT#	DESCRIPTION
KC01A	12VDC	DIN/HIRSCHMANN	KC05 RELIEF, CHECK, MANUAL RELEASE VALVE KIT WITH MICRO-SWITCH
KC01B	12VDC	DUAL 1/4" SPADE	KC07 RELIEF & CHECK VALVE KIT
KC01C	12VDC	SINGLE #10 UNF STUD	KC08 RELIEF VALVE KIT
KC01D	24VDC	DIN/HIRSCHMANN	KC14 RELIEF, CHECK, PNEUMATIC RELEASE VALVE KIT
KC01E	24VDC	DUAL 1/4" SPADE	KC15 RELIEF, CHECK, DC MANUAL RELEASE VALVE KIT
KC01F	24VDC	SINGLE #10 UNF STUD	KC18 RELIEF, CHECK, AC LEVER RELEASE VALVE KIT
KC01G	24VAC	DIN/HIRSCHMANN	KFC2 .5 GAL PRESSURE COMP FLOW CONTROLS
KC01H	230VAC	DIN/HIRSCHMANN	KFC4 1 GAL PRESSURE COMP FLOW CONTROLS
KC01J	115VAC	DIN/HIRSCHMANN	KFC6 1.5 GAL PRESSURE COMP FLOW CONTROLS
KC03	RELIEF, CHECK, MANUAL RELEASE VALVE KIT DIRECT ACTING		KFC8 2 GAL PRESSURE COMP FLOW CONTROLS

RESERVOIRS

KIT #	TANK	NOMINAL CAPACITY (GAL)	TANK LENGTH		USABLE OIL CAPACITY		HORIZONTAL	
			MM	INCH	LITRE	CU.IN	LITRE	CU.IN
KR12	STEEL	.5	216	8.50	1.4	85	1.6	90
KR14	STEEL	.75	305	12.00	2.4	138	2.2	135
KR15	STEEL	1.0	368	14.50	2.6	165	2.6	161
KR22	PLASTIC	.5	216	8.50	1.4	83	1.6	100
KR24	PLASTIC	.75	280	11.00	2.3	138	2.2	130
KR25	PLASTIC	1.0	356	14.00	3.3	200	2.9	175
KR40	STEEL	1.0	200	7.88	1.6	100	2.8	170
KR45	STEEL	1.2	250	9.84	2.6	160	3.6	220
KR41	STEEL	1.5	300	11.81	3.6	220	4.4	270
KR42	STEEL	2.0	400	15.75	5.6	340	5.9	360
KR46	STEEL	2.5	432	17.00	6.2	380	6.4	390
KR43	STEEL	3.0	550	21.65	8.5	520	8.2	500
KR44	STEEL	4.0	660	26.00	10.6	650	9.8	600
KR50	PLASTIC	1.0	190	7.50	1.9	120	3.1	186
KR55	PLASTIC	1.2	228	9.00	2.9	180	3.8	230
KR51	PLASTIC	1.5	279	11.00	4.3	260	4.7	286
KR52	PLASTIC	2.0	330	13.00	5.6	340	5.6	345
KR56	PLASTIC	2.5	381	15.00	6.9	420	6.6	400
KR53	PLASTIC	3.0	508	20.00	10.2	620	8.8	540
KR54	PLASTIC	4.0	660	26.00	14.1	860	11.7	715
KR71	STEEL	7.0	254	10.00	20	1250	—	—
KR72	STEEL	TANK NECK-RING KIT FOR USE WITH SELF-MANUFACTURED STEEL RESERVOIRS.						
KR73	STEEL	14	508	20.00	50	3000	—	—

PICK - A - PACK PRODUCT RANGE

PLUMBING

KH HORIZONTAL

KV VERTICAL

For flows over 3 GPM Order 1412-AA Filter



MANIFOLD BLOCKS

- KB11** SINGLE MANIFOLD BLOCK FOR D03 CETOP VALVE/SAE PORTS TOP MOUNT

- KB21** SINGLE MANIFOLD BLOCK FOR D03 CETOP VALVE/SAE PORTS SIDE MOUNT

- KB22** DOUBLE MANIFOLD BLOCK FOR D03 CETOP VALVE/SAE PORTS SIDE MOUNT

- KB23** TRIPLE MANIFOLD BLOCK FOR D03 CETOP VALVE SAE PORTS SIDE MOUNT

Note: Manifold blocks cannot be used with KN12 endheads.

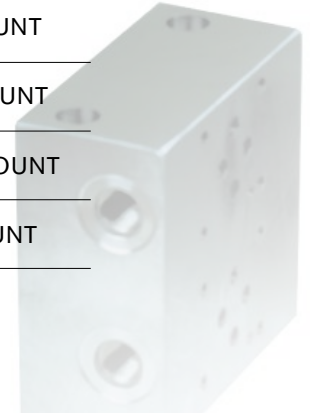

CARTRIDGE VALVE MANIFOLDS

- KDVC1** 12VDC 2P4W WITH DPO CHECKS **KDVC4** 24VDC 3P4W WITH DPO CHECKS

- KDVC2** 24VDC 2P4W WITH DPO CHECKS **KDVC5** 115VAC 3P4W WITH DPO CHECKS

- KDVC3** 12VDC 3P4W WITH DPO CHECKS **KDVC6** 230VAC 3P4W WITH DPO CHECKS

Note: Manifold valves cannot be used with KN12 endheads.



CORD SET

- KG11** 10 FT CONTROL HANDSET FOR SINGLE-ACTING UNITS

- KG12** 10 FT CONTROL HANDSET FOR SINGLE SOLENOID, DOUBLE-ACTING UNITS

- KG13** CONTROL HANDSET FOR DOUBLE SOLENOID, DOUBLE-ACTING UNITS

Please consult factory for other options



START SOLENOIDS

KIT #	VOLTAGE	DUTY	SERVICE PART#	GROUND	UL REC	KIT #	VOLTAGE	DUTY	SERVICE PART#	GROUND	UL REC
KS1	12VDC	INTERMITTENT	2145-AA	INT	NO	KS1P	12VDC	INTERMITTENT	4795-AA	INT	NO
							(NEW PLASTIC)				
KS2	24VDC	INTERMITTENT	2151-AA	INT	NO	KS2P	24VDC	INTERMITTENT	5024-AA	INT	NO
							(NEW PLASTIC)				
KS3	12VDC	INTERMITTENT	1866-CA	EXT	YES	KS3P	12VDC	INTERMITTENT	5022-AA	EXT	YES
							(NEW PLASTIC)				
KS4	24VDC	INTERMITTENT	2150-AA	EXT	YES	KS4P	24VDC	INTERMITTENT	5025-AA	EXT	YES
							(NEW PLASTIC)				
KS7	12VDC	200 AMP	3823-AA	EXT	YES	KS7P	12 12VDC	200 AMP	4764-AA	EXT	YES
	(NEW STEEL)	CONTINUOUS					CONTINUOUS				
KS8	24VDC	200 AMP	3822-AA	EXT	YES	KS8P	24VDC	100 AMP	5026-AA	EXT	YES
	(NEW STEEL)	CONTINUOUS					(NEW PLASTIC)	CONTINUOUS			

GLOBAL CUSTOMER SERVICE CENTERS

North America Headquarters

5885 11th Street
Rockford, IL 61109
USA

Customer Service/Order Entry

Tel: +1 800 541 1418
Fax: +1 800 288 7031

Send P.O's to: info@stonehydraulics.com

Technical Services

Tel: +1 800 477 8326
Fax: +1 800 765 8326

European Headquarters

Albert Thijsstraat 12
6471 WX Eygelshoven
The Netherlands
Tel: +31 45 567 8877

infoeurope@stonehydraulics.com

SEA Headquarters

20 Pioneer Crescent #06-01
West Park BizCentral
Singapore 628555
Tel: +65 6264 4366
Fax: +65 6265 9133

infoasia@stonehydraulics.com

India Headquarters

SPX Flow Technology (India) Pvt. Limited
Survey No. 275
Odhav, Ahmedabad - 382 415
Tel: +91-99099-85454
+91-97277-19950

india@stonehydraulics.com

China Headquarters

7F Treasury Building
1568 Huashan Road
Shanghai, 200052 China
Tel: +86 21 2208 5888
Fax: +86 21 2208 5682

infochina@stonehydraulics.com

Australia Headquarters

SPX Flow Technology Australia Pty Ltd
Quad 2, 6 Parkview Drive
Homebush Bay NSW 2127
Tel: +61 02 9763 4900
Fax: +61 02 9763 7888

Ft.aus.cs@spxflow.com

Distributed by:

Visit us at stonehydraulics.com to learn more.

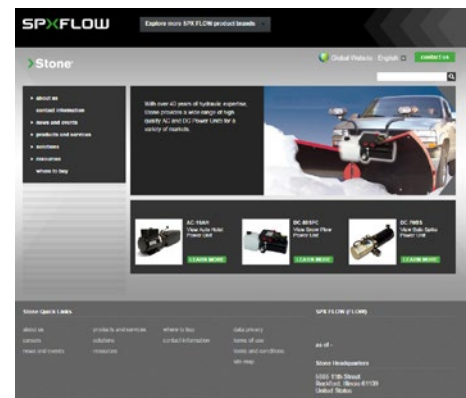

SPX FLOW, Inc. reserves the right to incorporate our latest design and material changes without notice or obligation.

Design features, materials of construction and dimensional data, as described in this bulletin, are provided for your information only and should not be relied upon unless confirmed in writing. Please contact your local sales representative for product availability in your region. For more information visit www.spxflow.com.

The green "S" and "X" are trademarks of SPX FLOW, Inc.

Bulletin: ST_SC 1 0 1 9

COPYRIGHT © 2018 SPX FLOW INC.