

➤ **Waukesha Cherry-Burrell®**

# Valve Key

BUTTERFLY, BALL, SINGLE SEAT, MIX PROOF VALVES



# TABLE OF CONTENTS

300/350 Series Ball Valve Key.....3-6

200 Series Butterfly Valve Key .....7-10

W60/W80 Series Single Seat Valve Key..... 11-19

W70 Series Mix Proof Valve Key .....20-27

D4 Series Mix Proof Valve Key.....28-34

# 300/350 Series Ball Valves

The Valve Key is designed to provide our customers with a clear and concise description of the valve required. The key number will define all areas of the valve's specification.

## Example Valve Order Number:

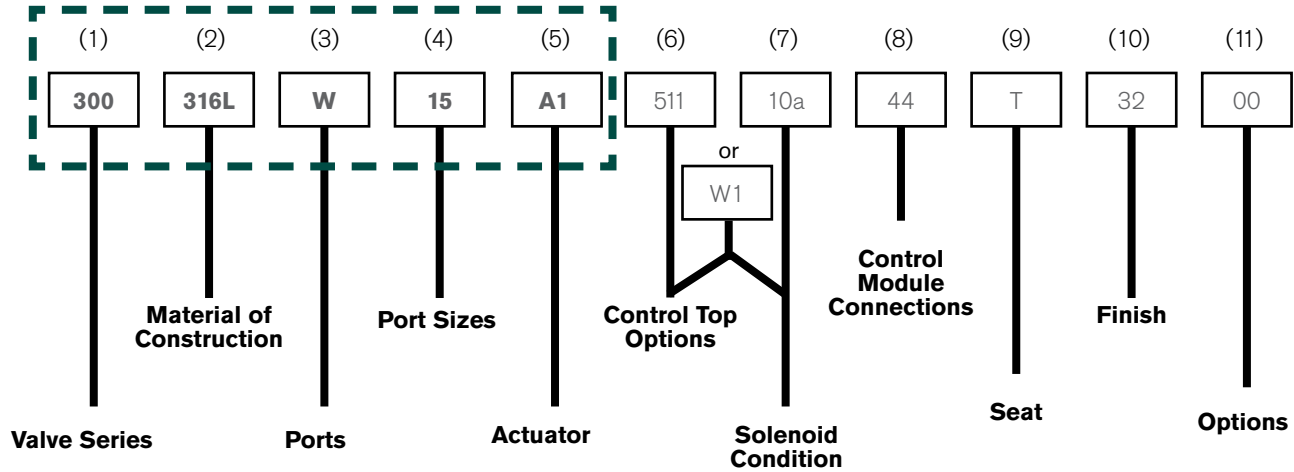

### (1) VALVE SERIES

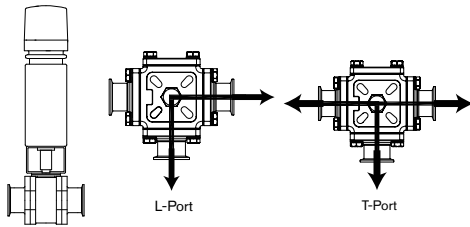

- 300** 2-way ball valve
- 350-L** 3-way ball valve<sup>1</sup> with L ports
- 350-T** 3-way ball valve<sup>1</sup> with T ports

<sup>1</sup>Available only with S-Line Ports

### (2) MATERIAL OF CONSTRUCTION

- 316L** Material

### (3) PORTS

- W** Buttweld
- S** S-Line

### (4) PORT SIZE(S)

- 050** .50" (13 mm)
- 075** .75" (19 mm)
- 10** 1.00" (25 mm)
- 15** 1.50" (38 mm)
- 20** 2.00" (51 mm)
- 25** 2.50" (64 mm)
- 30** 3.00" (76 mm)
- 40** 4.00" (102 mm)

### (5) ACTUATOR

- H** Manual Handle
- A1** 3" (80 mm) Linear Air to Spring Normally Closed
- A2** 3" (80 mm) Linear Air to Spring Normally Open
- A3** 3" (80 mm) Linear Air to Air Double Acting
- B1** 5" (125 mm) Linear Air to Spring Normally Closed
- B2** 5" (125 mm) Linear Air to Spring Normally Open
- B3** 5" (125 mm) Linear Air to Air Double Acting
- C1** 7" (180 mm) Linear Air to Spring Normally Closed
- C2** 7" (180 mm) Linear Air to Spring Normally Open
- C3** 7" (180 mm) Linear Air to Air Double Acting

R1C250, R1C450, R1C1000

Rack and Pinion Air to Spring Normally Closed

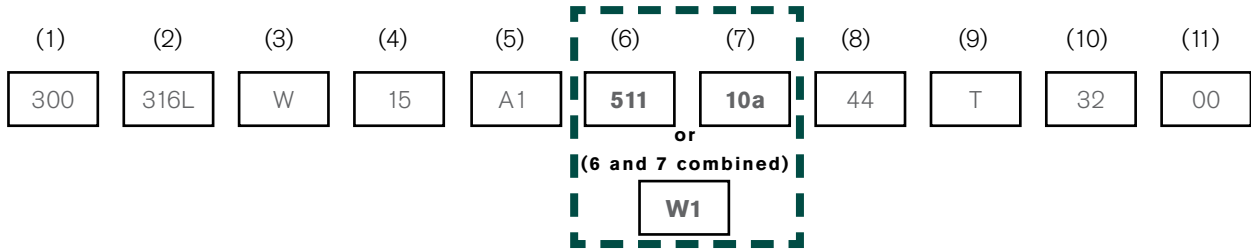

**(6) (7) SEPARATE SWITCHES/SOLENOIDS**

DESCRIPTION	CONTROL TOP MODEL & POSITION INDICATION	COMMUNICATION CARD	SENSOR VOLTAGE	NO SOLENOIDS	(1) 24V DC SOLENOID	(2) 24V DC SOLENOIDS
WCB Control Top (6 and 7 separate) <sup>6, 7</sup>	No sensors	None	-	501	505	506
	Set & Forget	None	24V DC	511	515	516
	IS Prox Sensor (2) <sup>2</sup>		Intrinsically Safe 5-25V DC	601	545I	546I
	Set & Forget	AS-i <sup>5</sup>	24V DC	611 (31 or 62)	615 (31 or 62)	616 (31 or 62)
	Prox sensor (2)			641 (31 or 62)	645 (31 or 62)	646 (31 or 62)
	Set & Forget	DeviceNet™	24 VDC <sup>8</sup>	711	715	716
	Prox sensor (2)			741	745	746
8681	Teach-In Position System	None	24V DC or 110V AC	8681(24VDC)		
	Teach-In Position System	AS-i <sup>5</sup>	24V DC	8681(ASI)	8681(ASI)	8681(ASI)
	Teach-In Position System	DeviceNet™	24V DC	8681(DNET)	8681(DNET)	8681(DNET)
Hazardous <sup>9</sup>	Prox sensors (2)	None	24V DC	XP541	XP545	-

<sup>2</sup> Requires amplifier (not included-provided by others)

<sup>5</sup> Append "(31)" or "(62)" for number of max nodes/slaves available on AS-i card

<sup>6</sup> WCB Top with stainless steel cover use prefix = "SS"

<sup>7</sup> WCB Control Top with NEMA 6 washdown kit append "(NEMA6)"

<sup>8</sup> DeviceNet™ on WCB control top requires PNP sensors

<sup>9</sup> Hazardous Top rated for Class I, Group B, C, D; Class II, Group E, F, G; Only available with (2) Prox Sensors; XP solenoid mounted externally; not available with bus communication

Consult factory for special control module requirements.

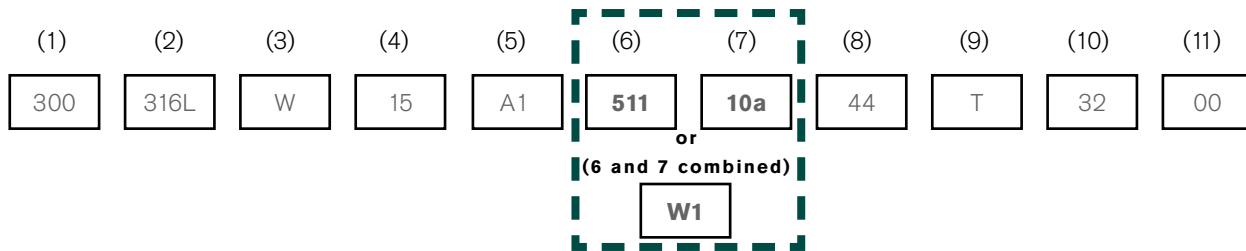

**(6) (7) COMBINED SWITCHES/SOLENOIDS**

DESCRIPTION	CONTROL TOP MODEL & POSITION INDICATION	COMMUNICATION CARD	VOLTAGE	NO SOLENOIDS	CONTROL TOP - (1) 24V DC SOLENOID	(1) 24V DC SOLENOID WITH NOT ELEMENT
CU4 (6 AND 7 COMBINED)	Prox sensors (2)	None	Dual Rated 24V DC / 110V AC	N/A	W1	W1NE
	Prox sensors (2)	AS-i <sup>5</sup>	24V DC		Y1 (62)	Y1NE (62)
	Non-contact Teach-in Sensor	None	24V DC		W1plus	W1plusNE
	Non-contact Teach-in Sensor	AS-i <sup>5</sup>	24V DC		Y1plus (62)	Y1plus NE (62)
	Non-contact Teach-in Sensor	IO Link	24V DC		S1plus	S1plusNE

DESCRIPTION	CONTROL TOP MODEL & POSITION INDICATION	COMMUNICATION CARD	VOLTAGE	BRACKET MOUNT - NO CONTROL TOP <sup>1</sup>
Manual Handle and Linear Actuators (Butterfly Valves Only)	Bracket Mount Prox sensor Ready	-	-	510
	Bracket Mount (2) Prox Open & Closed		24V DC	540
	Bracket Mount (2) Prox Open & Closed		110V AC	570
	Bracket Mount (2) Intrinsically Safe Prox Open & Closed		Intrinsically Safe	600
Rack & Pinion Actuator (Ball Valves Only)	Puck Sensor (2) Prox Open & Closed on top of actuator	-	Puck Sensor (2) Prox Open & Closed on top of actuator	L32

<sup>1</sup> Where proximity sensors are indicated, these are externally mounted in yoke area unless specified otherwise

<sup>2</sup> Requires amplifier (not included-provided by others)

<sup>3</sup> WCB Control Top with no sensors but with prox bracket = 501P or micro bracket = 501M

<sup>5</sup> Append "(31)" or "(62)" for number of max nodes/slaves available on AS-i card. 8681 control top only available with 62 node

<sup>6</sup> WCB Top with stainless steel cover use prefix = "SS"

<sup>7</sup> WCB Control Top with NEMA 6 washdown kit append "(NEMA6)"

<sup>8</sup> DeviceNet™ on WCB control top requires PNP sensors

Consult factory for special control module requirements.

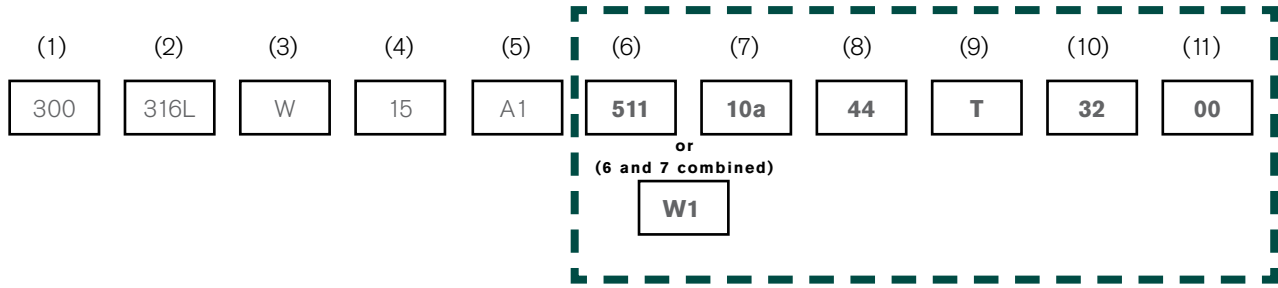

**(7) SOLENOID CONDITION**

- 00** No Control Module
- 10a** No Solenoid
- 11a** 1 Solenoid, Valve Condition Air/Spring
- 12** 2 Solenoid, Valve Condition Air/Air

**(8) CONTROL MODULE CONNECTIONS**

DESCRIPTION	OPTION NUMBER
No Connector	00
Strain Relief Connector	01
10 Pin Eurofast Connector	21
12 Pin Eurofast Connector	22
10cm Cord Set M12 12-Pin Eurofast <sup>1</sup>	22(10cm)
4 Pin Eurofast Connector <sup>2</sup>	24
10cm Cord Set M12 4-Pin Eurofast-AS-i <sup>1</sup>	24(ASI-10cm)
5 Pin Eurofast Connector	25
80cm Cord Set M12 5-Pin Eurofast-Dnet <sup>1</sup>	25(DNET-80cm)
6 Pin Eurofast Connecto	26
8 Pin Eurofast Connector,	28

<sup>1</sup> Includes connector on control module only, mating connector and cable by others. Available with 8681 control top only  
<sup>2</sup> Required on CU4 with AS-i and IO Link

**(9) SEAT/SEAL**

- T** PTFE

**(10) FINISH**

- 32** Standard Finish Machined <32Ra ID (.8µm)

**NOTE: Electropolish (EP) is in addition to the mechanical polish finish. Exterior 32Ra.**

**(11) OPTIONS**

- 00** No Options
- 08** SS Tags
- 18** Paper Tags

# Butterfly Valve Key

## 200 Series Butterfly Valves

The Valve Key is designed to provide our customers with a clear and concise description of the valve required.

The key number will define all areas of the valve's specification.

### Example Valve Order Number:

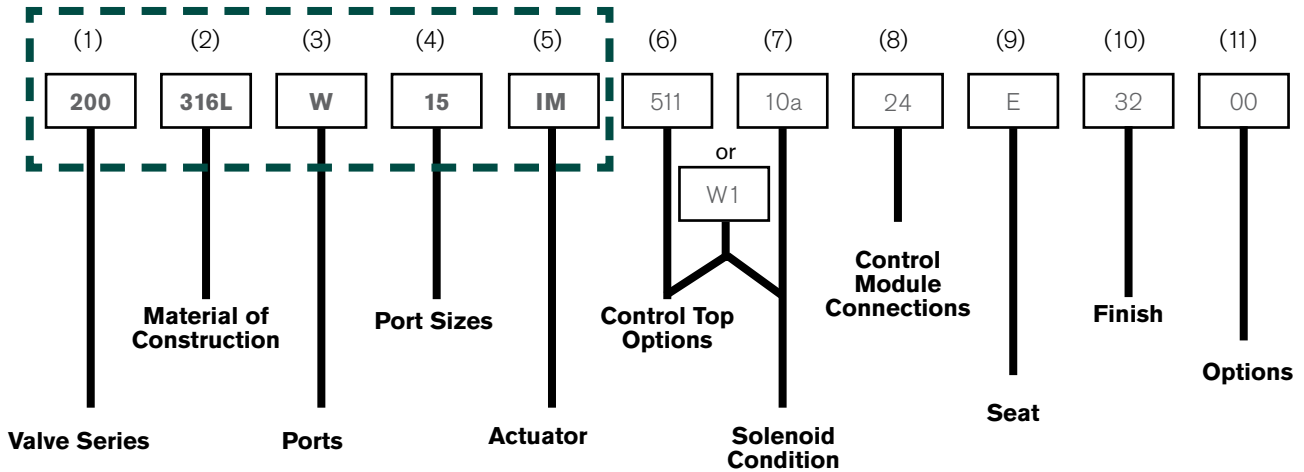

### (1) VALVE SERIES

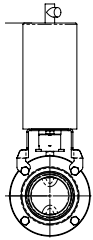

**200** Butterfly valve

### (4) PORT SIZE(S)

<b>050</b>	.50" (13 mm)
<b>075</b>	.75" (19 mm)
<b>10</b>	1.00" (25 mm)
<b>15</b>	1.50" (38 mm)
<b>20</b>	2.00" (51 mm)
<b>25</b>	2.50" (64 mm)
<b>30</b>	3.00" (76 mm)
<b>40</b>	4.00" (102 mm)
<b>60</b>	6.00" (152 mm)

### (2) MATERIAL OF CONSTRUCTION

**316L** Material

### (3) PORTS

**W** Butt weld  
**S** S-Line

### (5) ACTUATOR

<b>IM</b>	Intermediate Manual Handle
<b>P</b>	Pull Stop Handle
<b>PL</b>	Pull Stop with Lock Handle
<b>A1</b>	3" (80 mm) Linear Air to Spring Normally Closed
<b>A2</b>	3" (80 mm) Linear Air to Spring Normally Open
<b>A3</b>	3" (80 mm) Linear Air to Air Double Acting
<b>B1</b>	5" (125 mm) Linear Air to Spring Normally Closed
<b>B2</b>	5" (125 mm) Linear Air to Spring Normally Open
<b>B3</b>	5" (125 mm) Linear Air to Air Double Acting

**NOTE:** "A" size actuator used on ½" (13 mm) - 3" (76mm) valves  
 "B" size actuator used on 4" (102 mm) and 6" (152 mm) valves

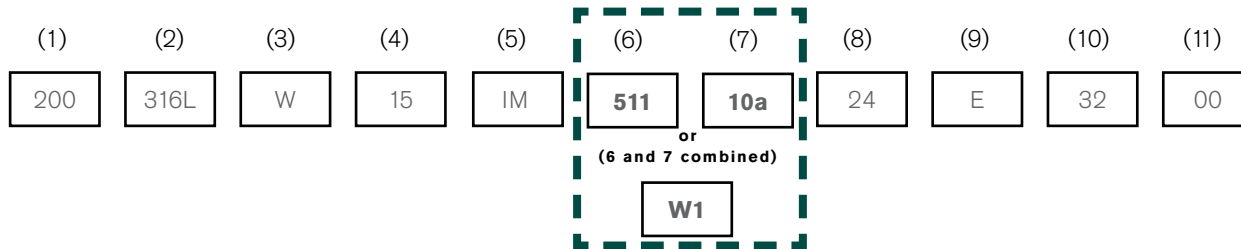

**(6) (7) SEPARATE SWITCHES/SOLENOIDS**

DESCRIPTION	CONTROL TOP MODEL & POSITION INDICATION	COMMUNICATION CARD	SENSOR VOLTAGE	NO SOLENOIDS	(1) 24V DC SOLENOID	(2) 24V DC SOLENOIDS
WCB Control Top (6 and 7 separate) <sup>6,7</sup>	No sensors	None	-	501	505	506
	Set & Forget	None	24V DC	511	515	516
	IS Prox Sensor (2) <sup>2</sup>		Intrinsically Safe 5-25V DC	601	545I	546I
	Set & Forget	AS-i <sup>5</sup>	24V DC	611 (31 or 62)	615 (31 or 62)	616 (31 or 62)
	Prox sensor (2)			641 (31 or 62)	645 (31 or 62)	646 (31 or 62)
	Set & Forget	DeviceNet™	24 VDC <sup>8</sup>	711	715	716
	Prox sensor (2)			741	745	746
8681	Teach-In Position System	None	24V DC or 110V AC	8681(24VDC)		
	Teach-In Position System	AS-i <sup>5</sup>	24V DC	8681(ASI)	8681(ASI)	8681(ASI)
	Teach-In Position System	DeviceNet™	24V DC	8681(DNET)	8681(DNET)	8681(DNET)
Hazardous <sup>9</sup>	Prox sensors (2)	None	24V DC	XP541	XP545	-

<sup>2</sup> Requires amplifier (not included-provided by others)

<sup>5</sup> Append "(31)" or "(62)" for number of max nodes/slaves available on AS-i card

<sup>6</sup> WCB Top with stainless steel cover use prefix = "SS"

<sup>7</sup> WCB Control Top with NEMA 6 washdown kit append "(NEMA6)"

<sup>8</sup> DeviceNet™ on WCB control top requires PNP sensors

<sup>9</sup> Hazardous Top rated for Class I, Group B, C, D; Class II, Group E, F, G; Only available with (2) Prox Sensors; XP solenoid mounted externally; not available with bus communication

Consult factory for special control module requirements.



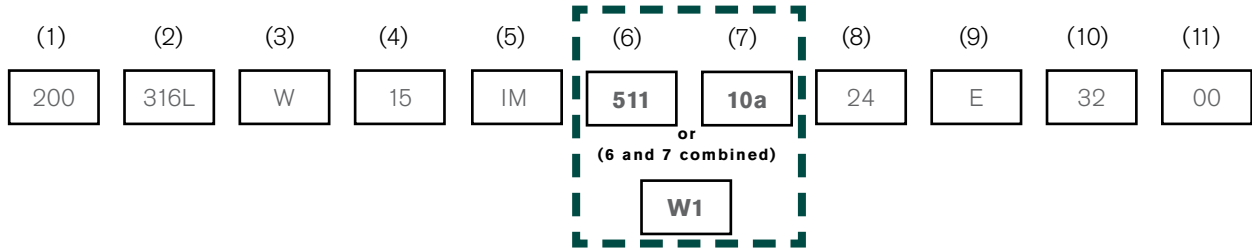

**(6) (7) COMBINED SWITCHES/SOLENOIDS**

DESCRIPTION	CONTROL TOP MODEL & POSITION INDICATION	COMMUNICATION CARD	VOLTAGE	NO SOLENOIDS	CONTROL TOP - (1) 24V DC SOLENOID	(1) 24V DC SOLENOID WITH NOT ELEMENT
CU4 (6 AND 7 COMBINED)	Prox sensors (2)	None	Dual Rated 24V DC / 110V AC	N/A	W1	W1NE
	Prox sensors (2)	AS-i <sup>5</sup>	24V DC		Y1 (62)	Y1NE (62)
	Non-contact Teach-in Sensor	None	24V DC		W1plus	W1plusNE
	Non-contact Teach-in Sensor	AS-i <sup>5</sup>	24V DC		Y1plus (62)	Y1plus NE (62)
	Non-contact Teach-in Sensor	IO Link	24V DC		S1plus	S1plusNE

DESCRIPTION	CONTROL TOP MODEL & POSITION INDICATION	COMMUNICATION CARD	VOLTAGE	BRACKET MOUNT - NO CONTROL TOP <sup>1</sup>
Manual Handle and Linear Actuators (Butterfly Valves Only)	Bracket Mount Prox sensor Ready	-	-	510
	Bracket Mount (2) Prox Open & Closed		24V DC	540
	Bracket Mount (2) Prox Open & Closed		110V AC	570
	Bracket Mount (2) Intrinsically Safe Prox Open & Closed		Intrinsically Safe	600
Rack & Pinion Actuator (Ball Valves Only)	Puck Sensor (2) Prox Open & Closed on top of actuator	-	Puck Sensor (2) Prox Open & Closed on top of actuator	L32

<sup>1</sup> Where proximity sensors are indicated, these are externally mounted in yoke area unless specified otherwise

<sup>5</sup> Append “(31)” or “(62)” for number of max nodes/slaves available on AS-i card. 8681 control top only available with 62 node

Consult factory for special control module requirements.

**(7) SOLENOID CONDITION**

- 00** No Control Module
- 10a** No Solenoid
- 11a** 1 Solenoid, Valve Condition Air/Spring
- 12** 2 Solenoid, Valve Condition Air/Air

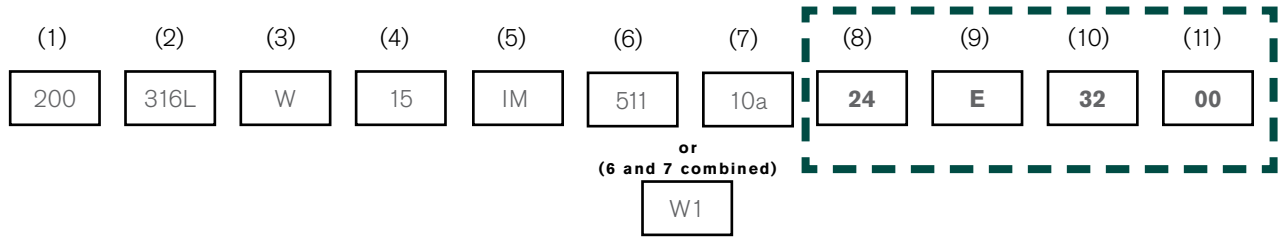

**(8) CONTROL MODULE CONNECTIONS**

DESCRIPTION	OPTION NUMBER
No Connector	00
Strain Relief Connector	01
10 Pin Eurofast Connector	21
12 Pin Eurofast Connector	22
10cm Cord Set M12 12-Pin Eurofast <sup>1</sup>	22(10cm)
4 Pin Eurofast Connector <sup>2</sup>	24
10cm Cord Set M12 4-Pin Eurofast-As-i* <sup>1</sup>	24(ASI-10cm)
5 Pin Eurofast Connector	25
80cm Cord Set M12 5-Pin Eurofast-Dnet <sup>1</sup>	25(DNET-80cm)
6 Pin Eurofast Connector	26
8 Pin Eurofast Connector	28

<sup>1</sup> Includes connector on control module only, mating connector and cable by others.  
Available with 8681 control top only  
<sup>2</sup> Required on CU4 with AS-i and IO Link

**(9) SEAT/SEAL**

- E** EPDM
- V** FKM

**(10) FINISH**

- 32** Standard Finish Machined <32Ra ID (.8µm)

**(11) OPTIONS**

- 00** No Options
- 08** SS Tags
- 18** Paper Tags

# Single Seat Valve Key

## W60/W80 Series Single Seat Valves

The Valve Key is designed to provide our customers with a clear and concise description of the valve required. The key number should be an 11 or 12-digit number defining all areas of the valve's specification.

Example: W61 shut off valve with a TS body configuration, butt weld ports, 1.5" (25 mm) size, 4" (101 mm) Air to Raise Actuator, 2 Proximity switches, 1 solenoid, Standard S/O Cord connector, Tef-Flow™ seat, Fluoroelastomer, 32Ra finish, and no special options.

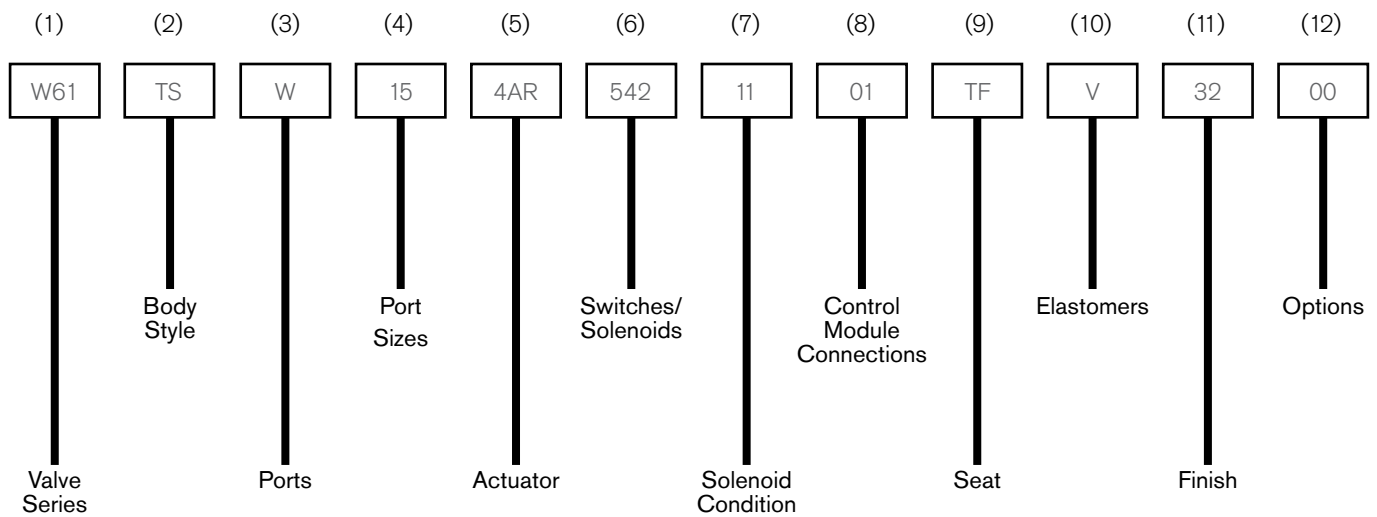

(1)	(2)	(3)	(4)	(5)	(6)	(7)	(8)	(9)	(10)	(11)	(12)
<b>W61</b>	TS	W	15	4AR	542	11	01	TF	V	32	00

## (1) VALVE SERIES

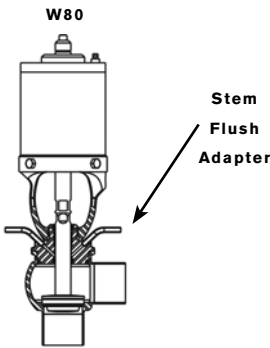
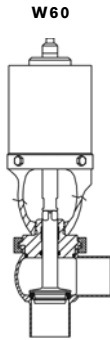

- W61** Shut-off
- W62** Divert
- W63** Reverse Acting Shuf-off
- W64** Tank Outlet Valve (Seat raises into tank)
- W64R** Tank Outlet Valve (Seat lowers into valve body)
- W65** Non Slamming Divert Valve
- W68** Throttling Valve
- W68R** Reverse Acting Throttling Valve
- W685** Non-Slamming Divert Throttling Valve
- W682** Conversion Throttling Valve
- W265** HTST Non Slam Flow Diversion Valve
- W262** HTST Flow Diversion Valve
  
- W81** Shut-off with stem flush adapter
- W82** Divert with stem flush adapter
- W83** Reverse Acting Shut-off with stem flush adapter
- W84** Tank Outlet Valve (Seat raises into tank) with stem flush adapter
- W84R** Tank Outlet Valve (Seat lowers into valve body) with stem flush adapter
- W85** Non Slamming Divert Valve with stem flush adapter
- W88** Throttling Valve with stem flush adapter
- W88R** Reverse Acting Throttling Valve with stem flush adapter
- W885** Non-Slamming Divert Throttling Valve with stem flush
- W882** Conversion Throttling Valve with stem flush adapter
- W285** HTST Non Slam Flow Diversion Valve with stem flush adapter
- W282** HTST Flow Diversion Valve

**NOTE: Over pressure valves are denoted by an "R" in the model (i.e. WR61) and use a W60 or W80 series valve with an adjustable-spring actuator.**

# Single Seat Valve Key

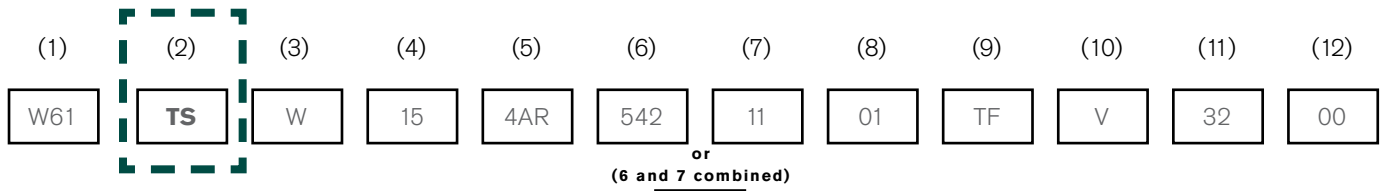

## (2) BODY CONFIGURATIONS

W1

### W61/W81 SHUT-OFF (W68/W88 THROTTLING)

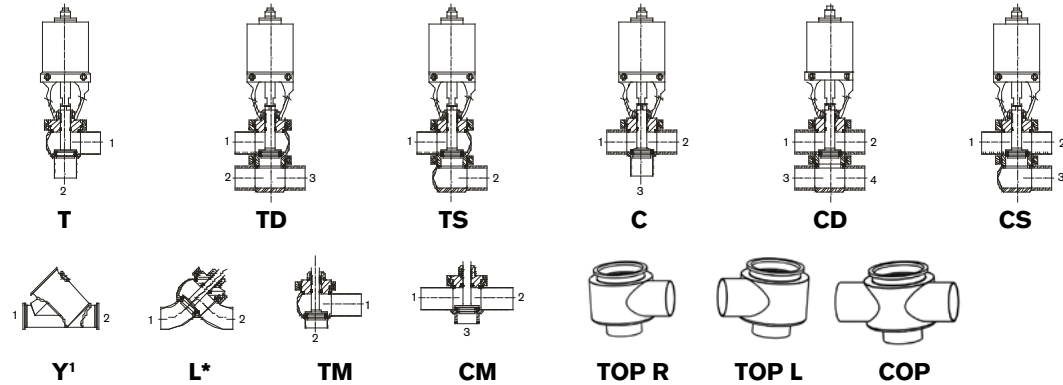

Also Available



Throttling Plug  
\*L body only  
available  
w/ high flow  
CV on  
throttling valves

### W62/W82 DIVERT

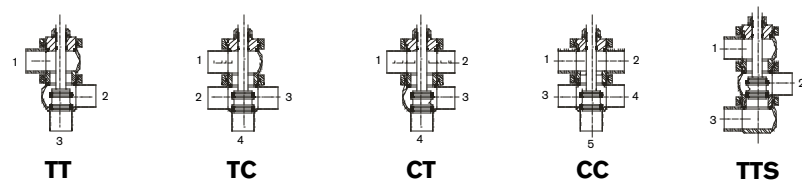

### W63/W83 SHUT-OFF (W68R/W88R THROTTLING)

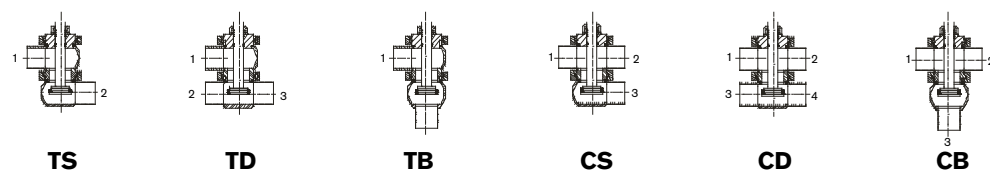

Also Available

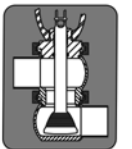

Throttling Plug

### W65/W85 DIVERT (W685/W885 THROTTLING)

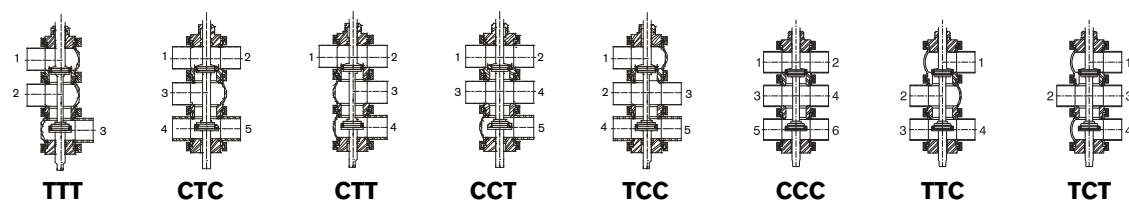

Also Available



Throttling Plug

### W64/W84 TANK OUTLET (NOTE: Tank Flanges sold separately)

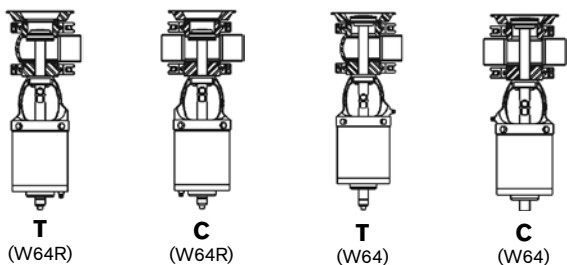

### W265/W285 FDV

### W262/W282 FDV

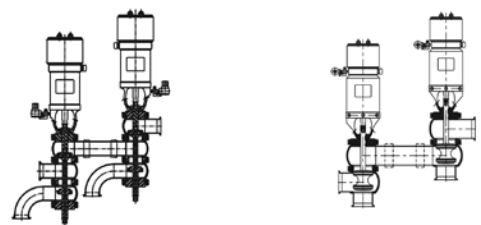

# Single Seat Valve Key

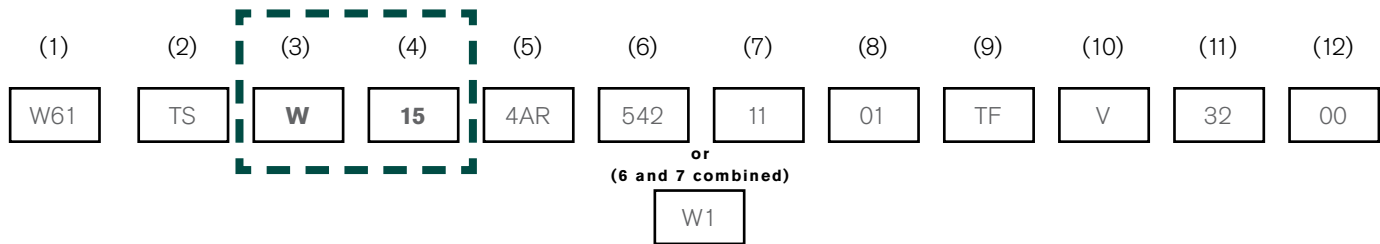

### (3) PORT(S)

- W** Buttweld
- S** S-Line

For mixed connection types, specify in order of port #.

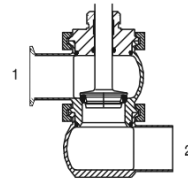

Example:  
W61-TS-SW

### (4) PORT SIZE(S)

- Standard Valves:**
- 10** 1" (25 mm) For mixed sized bodies indicate upper ports first.
  - 15** 1.5" (38 mm) Example: 1.5" (38 mm) Upper by 2" (51 mm) Lower is 1520.
  - 20** 2" (51 mm)
  - 25** 2.5" (64 mm) For reduced-seat bodies, indicate port size first, then plug size.
  - 30** 3" (76 mm) Example: 40/25 is 4" (101 mm) Body/2.5" (64 mm) plug size
  - 40** 4" (102 mm) Contact Factory to verify availability of mixed body and reduced-seat body sizes prior to placing an order.
  - 60** 6" (152 mm)

### Throttling Valves:

(See Cv Factor Chart below)

- 10(1.75)\*** 1" (25 mm) (Cv 1.75, 2.5, 5, 7.5)
- 15(10)** 1.5" (38 mm) (Cv 1.75, 2.5, 5, 7.5, 10 or Cv 35)
- 20(30)** 2" (51 mm) (Cv 30 or Cv 70)
- 25(60)** 2.5" (64 mm) (Cv 60 or Cv 120)
- 30(90)** 3" (76 mm) (Cv 90 or Cv 150)
- 40(110)** 4" (102 mm) (Cv 110 or Cv 210)

### Cv Factor Chart

\*Note: Cv rating follows port size.

% OF VALVE STROKE	VALVE STEM SIZE													
	1-1.5" (25-38 mm) REDUCED ORIFICE				1.5" (38 mm)		2" (50 mm)		2.5" (64 mm)		3" (76 mm)		4" (101 mm)	
	CV 1.75	CV 2.5	CV 5.0	CV 7.5	CV 10	CV 35	CV 30	CV 70	CV 60	CV 120	CV 90	CV 150	CV 110	CV 210
10	.175	.25	.50	.75	1	3.5	3	7	6	12	9	15	11	21
20	.35	.50	1	1.5	2	7	6	14	12	24	18	30	22	42
30	.525	.75	1.5	2.25	3	10.5	9	21	18	36	27	45	33	63
40	.70	1	2	3.0	4	14	12	28	24	48	36	60	44	84
50*	.875	1.25	2.5	3.75	5	17.5	15	35	30	60	45	75	55	105
60	1.05	1.5	3	4.5	6	21	18	42	36	72	54	90	66	126
70	1.225	1.75	3.5	5.25	7	24.5	21	49	42	84	63	105	77	147
80	1.4	2	4	6.0	8	28	24	56	48	96	72	120	88	168
90	1.575	2.25	4.5	6.75	9	31.5	27	63	54	108	81	135	99	189
100	1.75	2.5	5	7.5	10	35	30	70	60	120	90	150	110	210

\*Optimum operating point. Data is based on water at 70°F (21°C), specific gravity 1.

The Cv Factor is the flow coefficient in the full open position (100% stroke).

To calculate process Cv: 
$$C_v = \frac{\text{GPM}}{\sqrt{\Delta P (\text{psi}) / \text{SG}}} \quad K_v = \frac{\text{m}^3/\text{hr}}{\sqrt{\Delta P (\text{bar}) / \text{SG}}}$$

1 bar = 14.5 psi 
$$\text{m}^3/\text{hr} = \frac{\text{GPM}}{4.4}$$

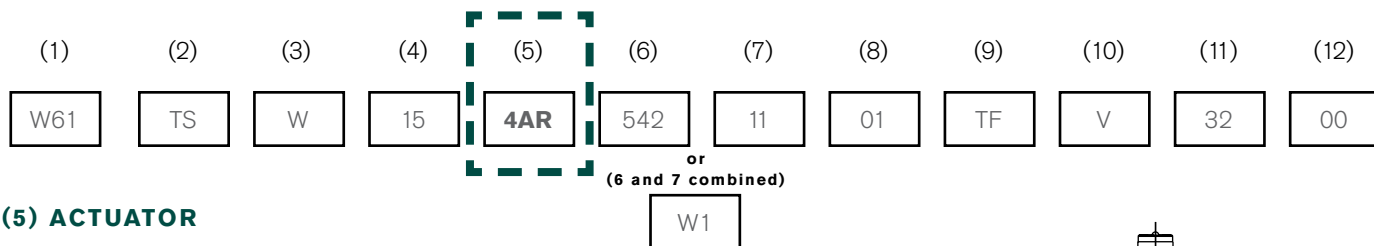

## (5) ACTUATOR

- 4AR** 4" (101 mm) Air to Raise
- 4HAR<sup>3</sup>** 4" (101 mm) Air to Raise, Heavy Duty Spring<sup>3</sup>
- 4RHAR<sup>4</sup>** 4" (101 mm) Air to Raise, Spring Adjustable, Heavy Duty Spring<sup>3</sup>
- 4ARLG** 4" (101 mm) Air to Raise, Long Stroke
- 4AL** 4" (101 mm) Air to Lower
- 4HAL<sup>3</sup>** 4" (101 mm) Air to Lower, Heavy Duty Spring<sup>3</sup>
- 4RHAL<sup>4</sup>** 4" (101 mm) Air to Lower, Spring Adjustable, Heavy Duty Spring<sup>3</sup>
- 4ALLG** 4" (101 mm) Air to Lower, Long Stroke
- 4AA** 4" (101 mm) Air to Air

- 5AR** 5" (127 mm) Air to Raise
- 5HAR<sup>3</sup>** 5" (127 mm) Air to Raise, Heavy Duty Spring<sup>3</sup>
- 5RHAR<sup>4</sup>** 5" (127 mm) Air to Raise, Spring Adjustable, Heavy Duty Spring<sup>3</sup>
- 5AL** 5" (127 mm) Air to Lower
- 5HAL<sup>3</sup>** 5" (127 mm) Air to Lower, Heavy Duty Spring<sup>3</sup>
- 5RHAL<sup>4</sup>** 5" (127 mm) Air to Lower, Spring Adjustable, Heavy Duty Spring<sup>3</sup>
- 5AA** 5" (127 mm) Air to Air

- 6AR** 6" (152 mm) Air to Raise
- 6HAR<sup>3</sup>** 6" (152 mm) Air to Raise, Heavy Duty Spring<sup>3</sup>
- 6RHAR<sup>4</sup>** 6" (152 mm) Air to Raise, Spring Adjustable, Heavy Duty Spring<sup>3</sup>
- 6ARLG** 6" (152 mm) Air to Raise, Long Stroke
- 6AL** 6" (152 mm) Air to Lower
- 6HAL<sup>3</sup>** 6" (152 mm) Air to Lower, Heavy Duty Spring<sup>3</sup>
- 6RHAL<sup>4</sup>** 6" (152 mm) Air to Lower, Spring Adjustable, Heavy Duty Spring<sup>3</sup>
- 6ALLG** 6" (152 mm) Air to Lower, Long Stroke
- 6AA** 6" (152 mm) Air to Air
- 6ARY<sup>2</sup>** 6" (152 mm) Air to Raise, Extra Long Stroke
- 6ALY<sup>2</sup>** 6" (152 mm) Air to Lower, Extra Long Stroke

- A1** 3" (74 mm) Air to Raise, Maintenance-Free
- A2** 3" (74 mm) Air to Lower, Maintenance-Free
- A3** 3" (74 mm) Air to Air, Maintenance-Free
- B1** 4.5" (110 mm) Air to Raise, Maintenance-Free
- B2** 4.5" (110 mm) Air to Lower, Maintenance-Free
- B3** 4.5" (110 mm) Air to Air, Maintenance-Free
- C1** 6.5" (165 mm) Air to Raise, Maintenance-Free
- C2** 6.5" (165 mm) Air to Lower, Maintenance-Free
- C3** 6.5" (165 mm) Air to Air, Maintenance-Free

<sup>2</sup> Used with Y-Body valves. Consult with application engineering for use with 6" (152 mm) OD size valves.

<sup>3</sup> Use TFP metal or TR seats for heavy spring actuators.

<sup>4</sup> Used with over-pressure valves, use TFP or metal seats.

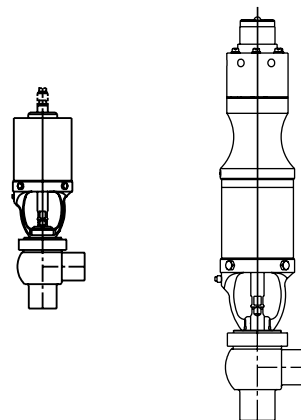

- 4ARP** 4" (101 mm) Air to Raise w/positioner
- 4ALP** 4" (101 mm) Air to Lower w/positioner
- 5ARP** 5" (127 mm) Air to Raise w/positioner
- 5ALP** 5" (127 mm) Air to Lower w/positioner
- 6ARP** 6" (152 mm) Air to Raise w/positioner
- 6ALP** 6" (152 mm) Air to Lower w/positioner

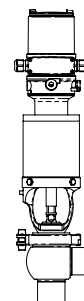

- 4ALEP** 4" (102 mm) Air to Lower, Electropneumatic Positioner
- 5ALEP** 5" (127 mm) Air to Lower, Electropneumatic Positioner
- 6ALEP** 6" (152 mm) Air to Lower, Electropneumatic Positioner
- 4AREP** 4" (102 mm) Air to Raise, Electropneumatic Positioner
- 5AREP** 5" (127 mm) Air to Raise, Electropneumatic Positioner
- 6AREP** 6" (152 mm) Air to Raise, Electropneumatic Positioner

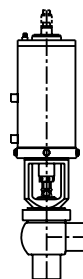

- 4AR3** 4" (101 mm) Air to Raise, 3 position
- 4AL3** 4" (101 mm) Air to Lower, 3 position

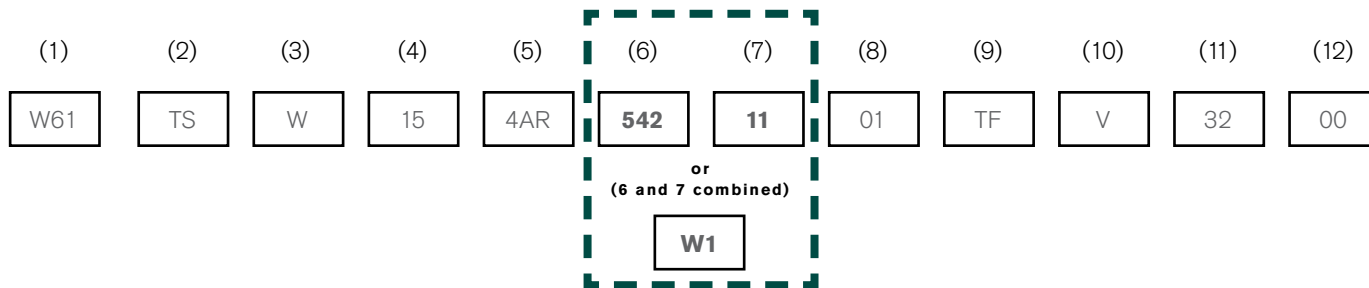

## (6) (7) SEPARATE SWITCHES/SOLENOIDS

DESCRIPTION	CONTROL TOP MODEL & POSITION INDICATION	COMMUNICATION CARD	SENSOR VOLTAGE	NO SOLENOIDS	(1) 24V DC SOLENOID	(2) 24V DC SOLENOIDS
WCB Control Top (6 and 7 separate) <sup>6,7</sup>	No sensors	None	-	501	505	506
	Set & Forget	None	24V DC	511	515	516
	IS Prox Sensor (2) <sup>2</sup>		Intrinsically Safe 5-25V DC	601	5451	5461
	Set & Forget	AS-i <sup>5</sup>	24V DC	611 (31 or 62)	615 (31 or 62)	616 (31 or 62)
	Prox sensor (2)			641 (31 or 62)	645 (31 or 62)	646 (31 or 62)
	Set & Forget	DeviceNet™	24 VDC <sup>8</sup>	711	715	716
	Prox sensor (2)			741	745	746
8681	Teach-In Position System	None	24V DC or 110V AC	8681(24VDC)		
	Teach-In Position System	AS-i <sup>5</sup>	24V DC	8681(ASI)	8681(ASI)	8681(ASI)
	Teach-In Position System	DeviceNet™	24V DC	8681(DNET)	8681(DNET)	8681(DNET)
Hazardous <sup>9</sup>	Prox sensors (2)	None	24V DC	XP541	XP545	-

<sup>2</sup> Requires amplifier (not included-provided by others)

<sup>5</sup> Append "(31)" or "(62)" for number of max nodes/slaves available on AS-i card

<sup>6</sup> WCB Top with stainless steel cover use prefix = "SS"

<sup>7</sup> WCB Control Top with NEMA 6 washdown kit append "(NEMA6)"

<sup>8</sup> DeviceNet™ on WCB control top requires PNP sensors

<sup>9</sup> Hazardous Top rated for Class I, Group B, C, D; Class II, Group E, F, G; Only available with (2) Prox Sensors; XP solenoid mounted externally; not available with bus communication

Consult factory for special control module requirements.



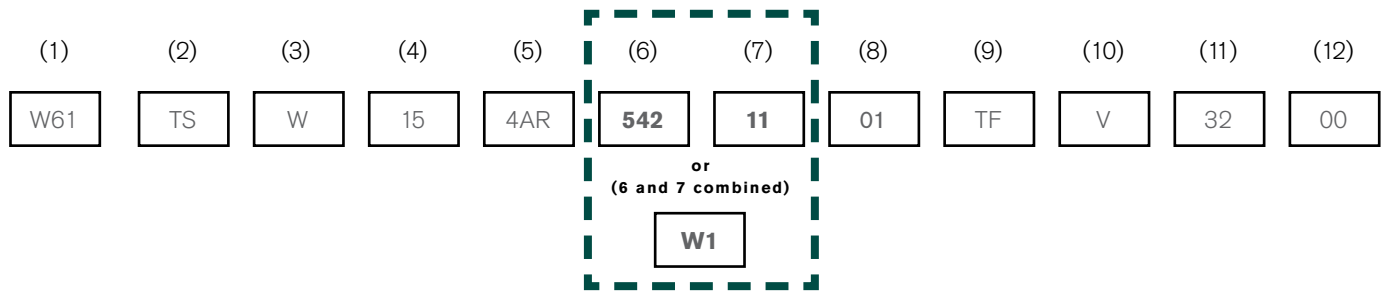

## (6) (7) COMBINED SWITCHES/SOLENOIDS

DESCRIPTION	CONTROL TOP MODEL & POSITION INDICATION	COMMUNICATION CARD	VOLTAGE	NO SOLENOIDS	CONTROL TOP - (1) 24V DC SOLENOID	(1) 24V DC SOLENOID WITH NOT ELEMENT
CU4 (6 AND 7 COMBINED)	Prox sensors (2)	None	24V DC	N/A	W1	W1NE
	Prox sensors (2)	AS-i <sup>5</sup>	24V DC		Y1 (62)	Y1NE (62)
	Non-contact Teach-in Sensor	None	24V DC		W1plus	W1plusNE
	Non-contact Teach-in Sensor	AS-i <sup>5</sup>	24V DC		Y1plus (62)	Y1plus NE (62)
	Non-contact Teach-in Sensor	IO Link	24V DC		S1plus	S1plusNE

DESCRIPTION	CONTROL TOP MODEL & POSITION INDICATION	COMMUNICATION CARD	VOLTAGE	NO CONTROL TOP
NO CONTROL TOP	No sensors	-	-	000
	No sensors, WCB Control top indicator stem			001
	No sensors, WCB Control top indicator stem - Set & Forget			001SF

DESCRIPTION	ACTUATOR OPTION & POSITION INDICATION	COMMUNICATION CARD	VOLTAGE	BRACKET MOUNT - NO CONTROL TOP <sup>1</sup>
MAINTAINABLE ACTUATORS - NO CONTROL TOP	Set & Forget Only	-	24V DC	510
	Prox sensor (2)		Dual Rated 24V DC / 110V AC <sup>2</sup>	540
	Prox Sensor (2) <sup>2</sup>		Intrinsically Safe 5-25V DC	600
	IS Prox sensor (2)		Intrinsically Safe 5-25V DC	YS2I
MAINTENANCE-FREE ACTUATORS - NO CONTROL TOP	Bracket Mount (2) Prox Open & Closed		24V DC	

<sup>1</sup> Where proximity sensors are indicated, these are externally mounted on top of actuators unless specified otherwise with "YS" for yoke switch

<sup>2</sup> Requires amplifier (not included-provided by others)

<sup>3</sup> WCB Control Top with no sensors but with prox bracket = 501P or micro bracket = 501M

<sup>4</sup> When one proximity or microswitch is supplied, Default is as follows: W61, W62, W64R, W65 – lower position W63, W64 – Upper position

<sup>5</sup> Append "(31)" or "(62)" for number of max nodes/slaves available on AS-i card

<sup>6</sup> WCB Top with stainless steel cover use prefix = "SS"

<sup>7</sup> WCB Control Top with NEMA 6 washdown kit append "(NEMA6)"

<sup>8</sup> DeviceNet™ on WCB control top requires PNP sensors

<sup>9</sup> Hazardous Top rated for Class I, Group B, C, D; Class II, Group E, F, G; Only available with (2) Prox Sensors; XP solenoid mounted externally; not available with bus communication

Consult factory for special control module requirements.

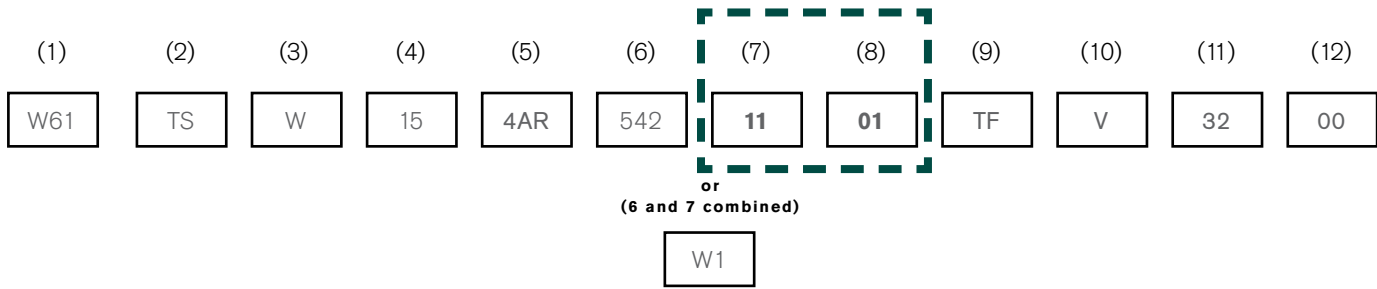

## (7) SOLENOID CONDITION

DESCRIPTION	CONDITION NO.
No Control Module	00
Single Seat - No Solenoid - AR	10
Single Seat - No Solenoid - AL & Air to Air	10a
Single Seat - 1 Solenoid - AR	11
Single Seat - 1 Solenoid - AL	11a
Single Seat - 2 Solenoid - Air Boost & Air to Air	12

**Note:** For Single Seat Valves AR = Air to Raise Actuator, AL = Air to Lower Actuator

## (8) CONTROL MODULE CONNECTIONS

DESCRIPTION	OPTION NUMBER
No Connector	00
Strain Relief Connector	01
10 Pin Eurofast Connector	21
12 Pin Eurofast Connector	22
10cm CORD SET M12 12-PIN EUROFAST <sup>2</sup>	22(10cm)
4 Pin Eurofast Connector <sup>3</sup>	24
10cm CORD SET M12 4-PIN EUROFAST-ASi <sup>2</sup>	24(ASi-10cm)
5 Pin Eurofast Connector	25
80cm CORD SET M12 5-PIN EUROFAST-DNET <sup>2</sup>	25(DNET-80cm)
6 Pin Eurofast Connector	26
8 Pin Eurofast Connector	28

**Includes connector on control module only, mating connector**

<sup>1</sup> Available on maintenance-free actuator only

<sup>2</sup> Available with 8681 control top only

<sup>3</sup> Required on CU4 with AS-i and IO Link

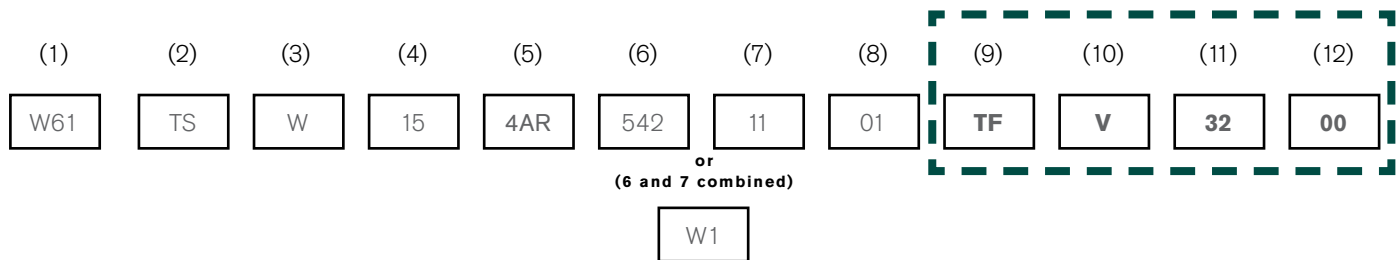

## (9) SEAT

**TF** Tef-Flow™  
**TFP** Tef-Flow™ P\*\*  
**TFPMD** Tef-Flow™ P-Metal-Detectable  
**TR** Tri Ring\*, \*\*\*  
**M** Metal

**Tef-Flow™  
(TF)**

**Tef-Flow™ “P”  
(TFP)**

**Tef-Flow™ “P”  
Metal-Detectable  
(TFPMD)**

**Tri Ring  
(TR)**

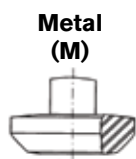

**Throttling Stem  
Tri Ring Seat  
(TR)\***



**Throttling Stem  
Metal Seat  
(M)**

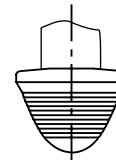

\*TR seat not available on CV 1.75, 2.5, 5.0 & 7.5 and 5ALD & 5ALDP actuated throttling valves.

\*\*TFP used on all over-pressure, Y-body, W262 and W265 valves. Heavy spring actuators are required.

\*\*\*6” (152 mm) valves only available with TR seats.

## (10) ELASTOMER

(Specifies materials for all gaskets, O-rings, and Tri Ring seals)

**E** EPDM  
**V** Fluoroelastomer  
**X** Optional Elastomer (specify)  
**EMD** EPDM-Metal-Detectable  
**VMD** FKM-Metal-Detectable

Contact Factory for special requirements.

## (11) FINISH

**32** Standard Finish Machined <32Ra ID (.8µm)  
**15** 15Ra Mechanical Polish ID (.2µm)

## (12) OPTIONS

DESCRIPTION	OPTION NUMBER
No Options	00
High Pressure Adapter and clamp	04
Heat Certification / MTR's	06
SS Tags	08
Wiping Stems Seal	10
Paper Tags	18

For multiple options: Example: High Pressure Stem Adapter & Mill Test-04,06.

# Mix Proof Valve Key

## W70 Series Mix Proof Valves

The Valve Key is designed to provide our customers with a clear and concise description of the valve required.

The key number should be an 11 or 12-digit number defining all areas of the valve's specification.

Example: W71 Mix Proof valve with an E1 one piece body, butt weld ports, 2" (51 mm) size, seat lifting actuator, WCB control top, (2) proximity switches, and (3) solenoids, 10 Pin Eurofast connector, Tri Ring seats, Fluoroelastomer, 32 Ra Finish, and no options.

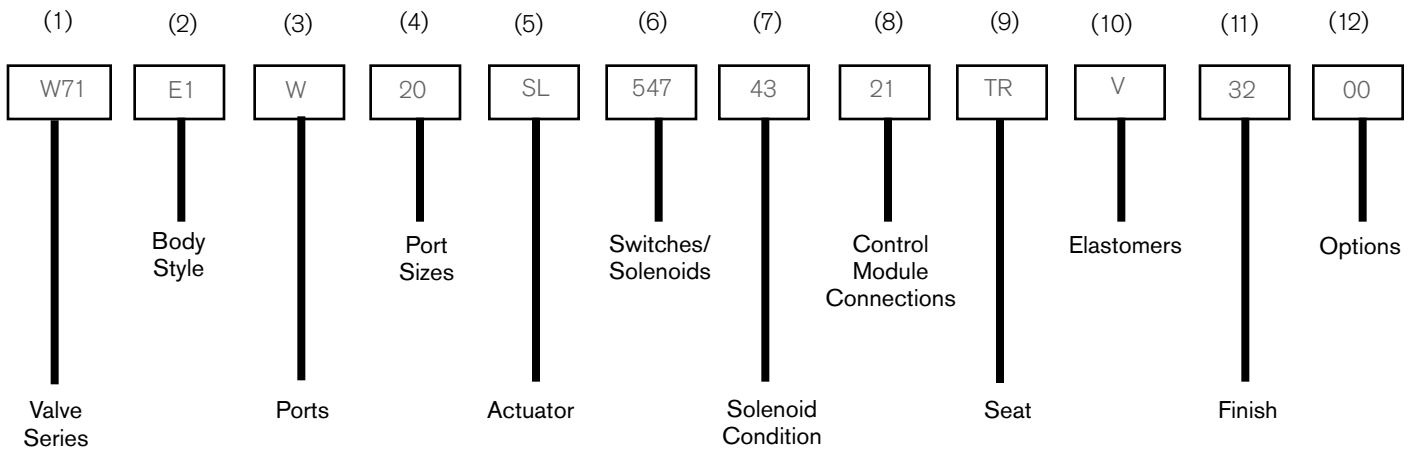

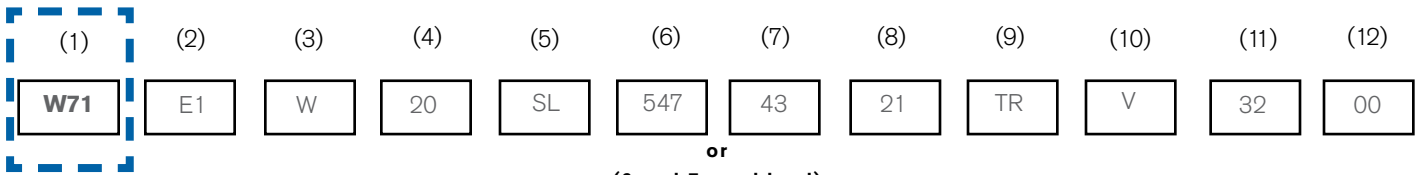

or  
(6 and 7 combined)



**(1) VALVE SERIES**

- W71** General Purpose Mix Proof
- W71 Tank Outlet** General Purpose Mix Proof
- W72RS** Minimum Spill Mix Proof
- W72RSP** Particulate Mix Proof
- W72RS Tank Outlet** Minimum Spill Mix Proof
- W73** Divert Mix Proof
- W75CP Tank Outlet** PMO Mix Proof with seat cleaning

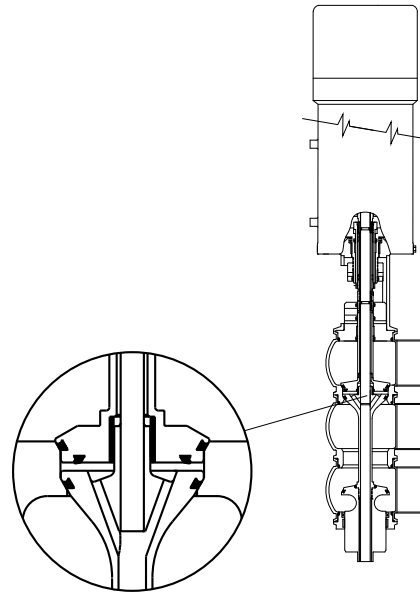
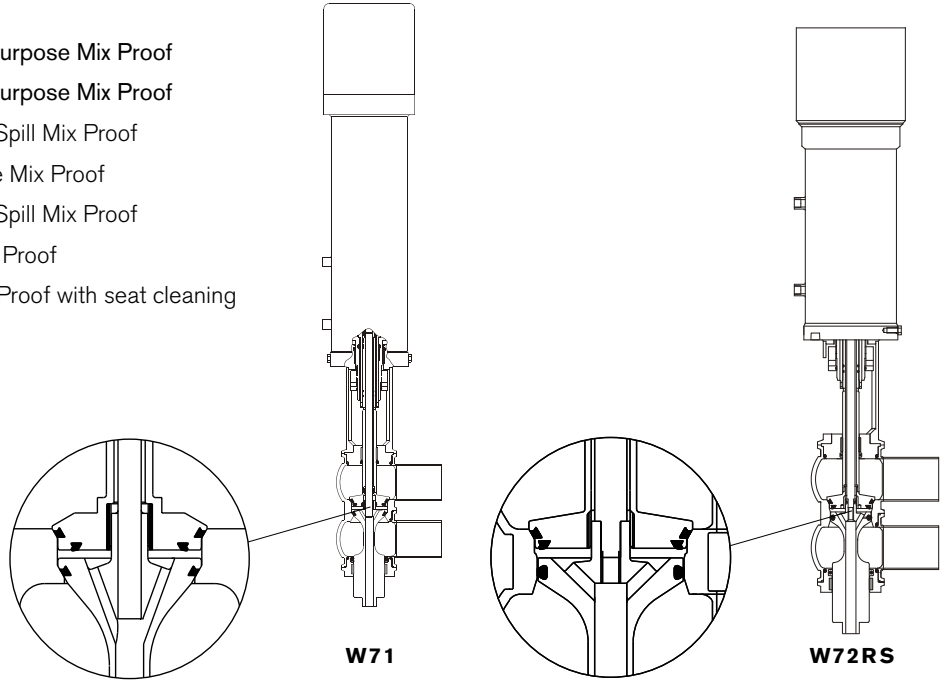

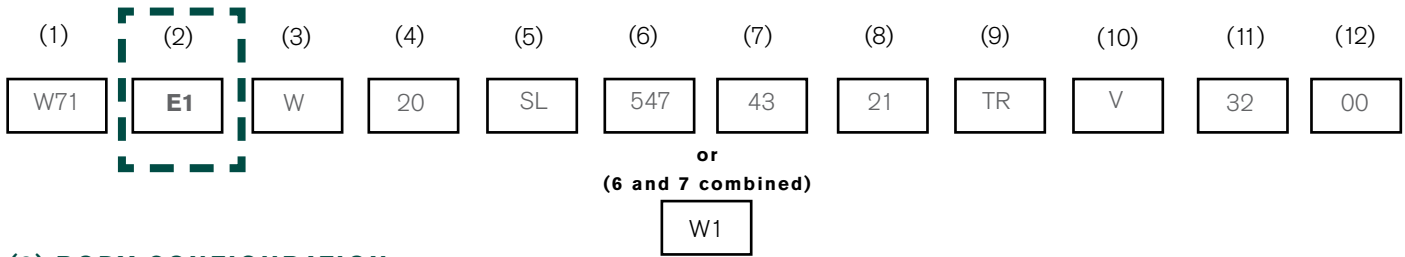

**(2) BODY CONFIGURATION**

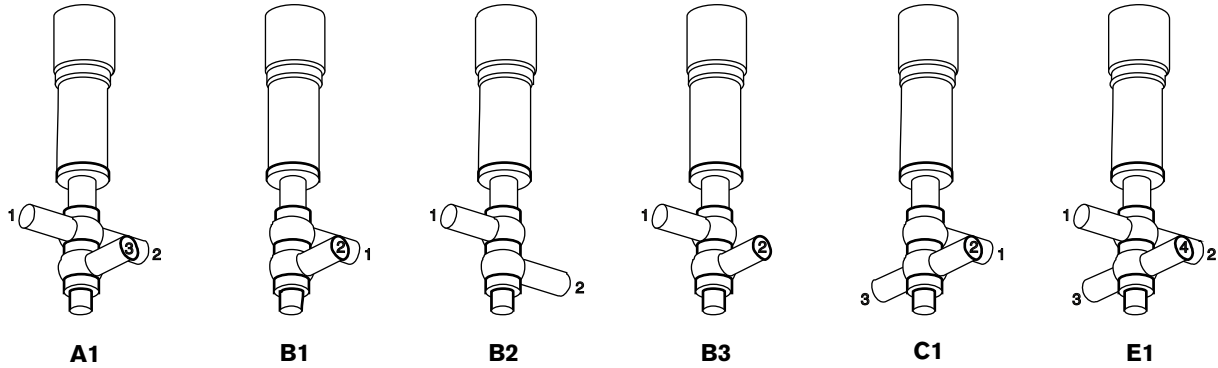

**Two Piece Clamped Bodies\***

**Tank Outlet Bodies**

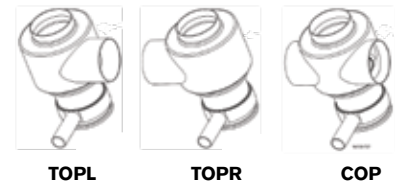
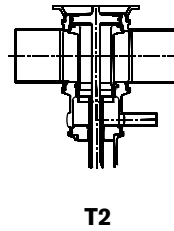
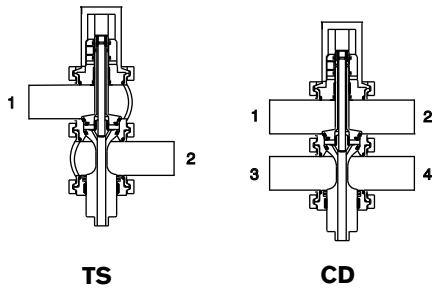

**W73 - Divert**

**Three Piece Clamped Bodies\***

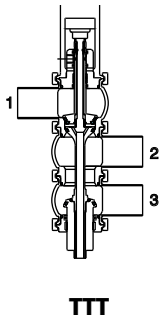

\*Clamped bodies allow ports to be rotated in any direction.  
Note: Indicate "none" for valve insert less body

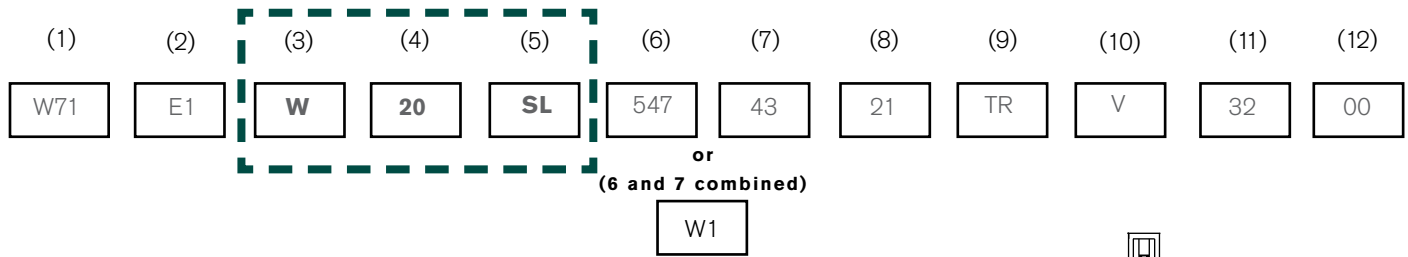

### (3) PORTS

- W** Butt Weld
- S** S-Line

For mixed connection types, specify in order of port # shown in body configuration see page 22.

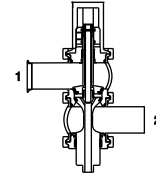

Example **W71-TS-SW**

### (4) PORTS SIZE (S)

Tube Size OD:		IPS Sch 5s:	
<b>15</b>	1.5" (38 mm)	<b>20V</b>	2" (51 mm)
<b>20</b>	2" (51 mm)	<b>30V</b>	3" (76 mm)
<b>25</b>	2.5" (64 mm)	<b>40V</b>	4" (102 mm)
<b>30</b>	3" (76 mm)	<b>60V</b>	6" (152 mm)
<b>40</b>	4" (102 mm)		
<b>60</b>	6" (152 mm)		

For mixed sized bodies indicate upper ports first.

Example: 1.5" (38 mm) Upper by 2" (51mm) Lower is 1520.

Contact Factory to verify availability of mixed body sizes prior to placing an order.

### (5) ACTUATOR

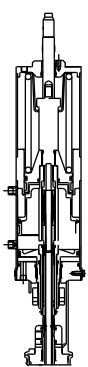

**SL** Seat Lifting

Fully maintainable  
Standard with quick exhaust  
valve on lower seat lift air  
connection

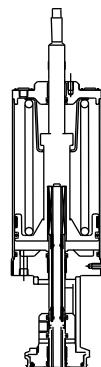

**NSL** Non Seat Lifting

Fully maintainable

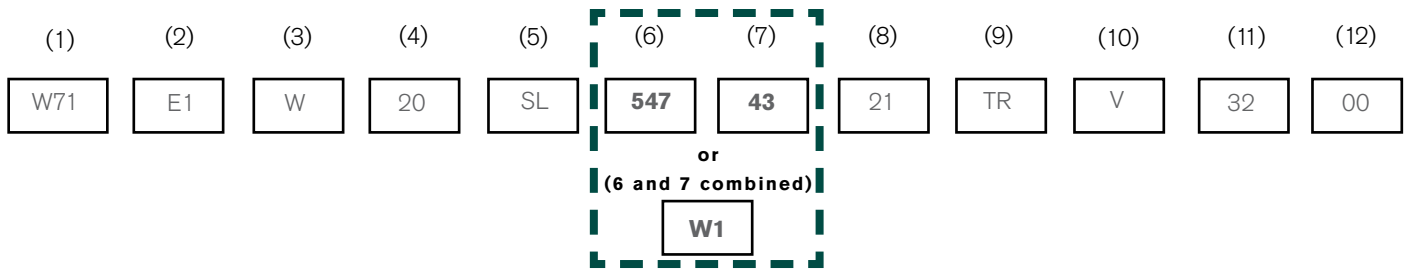

**(6) (7) SEPARATE SWITCHES/SOLENOIDS**

DESCRIPTION	CONTROL TOP MODEL & POSITION INDICATION	COMMUNICATION CARD	SENSOR VOLTAGE	NO SOLENOIDS	(1) 24V DC SOLENOID	(3) 24V DC SOLENOIDS
WCB Control Top (6 and 7 separate) <sup>6,7</sup>	No sensors <sup>3</sup>	None	-	501	505	507
	Set & Forget <sup>11</sup>	None	24V DC	511	515	517
	Prox sensor (2)		Dual Rated 24V DC / 110V AC	541	545	547
	Prox sensor (2) Control Top, (1) External Yoke Mounted <sup>11</sup>			801	805	807
	Prox Sensor (2) <sup>2</sup>			Intrinsically Safe 5-25V DC	601	545I
	Set & Forget <sup>11</sup>		AS-i <sup>5</sup>	24V DC	611 (31 or 62)	615 (31 or 62)
	Prox sensor (2)	641 (31 or 62)			645 (31 or 62)	647 (31 or 62)
	Prox sensor (2) Control Top, (1) External Yoke Mounted <sup>10</sup>	811 (31 or 62)			815 (31 or 62)	817 (31 or 62)
	Set & Forget <sup>11</sup>	DeviceNet™	24 VDC <sup>8</sup>	711	715	717
	Prox sensor (2)			741	745	747
Prox sensor (2) Control Top, (1) External Yoke Mounted <sup>10</sup>	821			825	827	
8681	Teach-In Position System	None	24V DC or 110V AC	8681(24VDC or 120VAC)	8681 (24VDC)	8681 (24VDC)
	Teach-In Position System	AS-i <sup>5</sup>	24V DC	8681(ASI)	8681(ASI)	8681(ASI)
	Teach-In Position System	DeviceNet™	24V DC	8681(DNET)	8681(DNET)	8681(DNET)
Hazardous <sup>9</sup>	Prox sensors (2)	None	24V DC	XP541	XP545	-

<sup>1</sup> Where proximity sensors are indicated, these are externally mounted on top of actuators unless specified otherwise

<sup>2</sup> Requires amplifier (not included-provided by others)

<sup>5</sup> Append "(31)" or "(62)" for number of max nodes/slaves available on AS-I card

<sup>6</sup> WCB Top with stainless steel cover use prefix = "SS"

<sup>7</sup> WCB Control Top with NEMA 6 washdown kit append "(NEMA6)"

<sup>8</sup> DeviceNet™ on WCB control top requires PNP sensors

<sup>9</sup> Hazardous Top rated for Class I, Group B, C, D; Class II, Group E, F, G; Only available with (2) Prox Sensors; XP solenoid mounted externally; not available with bus communication

<sup>10</sup> Indicates PMO control top options, the 3rd proximity switch is yoke mounted. For 8681 top with yoke prox, specify code "43" in the solenoid condition of the valve key

<sup>11</sup> Set & Forget sensor not available on W72 series valves

Consult factory for special control module requirements.



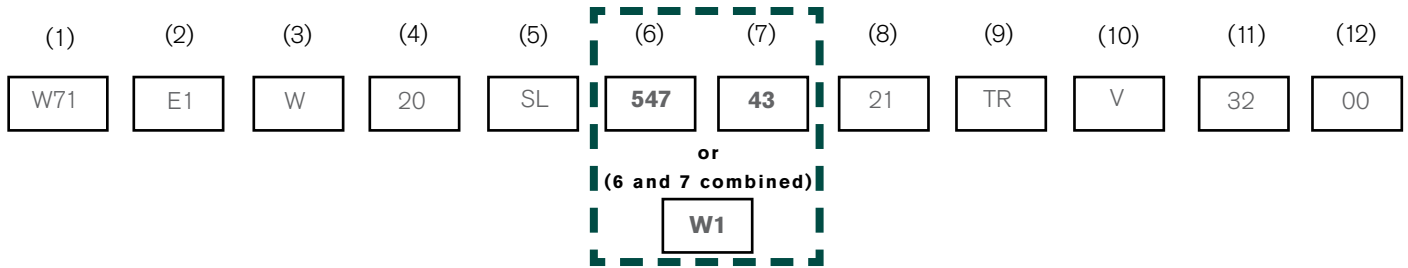

**(6) (7) COMBINED SWITCHES/SOLENOIDS**

DESCRIPTION	CONTROL TOP MODEL & POSITION INDICATION	COMMUNICATION CARD	VOLTAGE	NO SOLENOIDS	CONTROL TOP - (1) 24V DC SOLENOID	(3) 24V DC SOLENOIDS
CU4 (6 and 7 combined)	Prox sensors (2)	None	Dual Rated 24V DC / 110V AC	N/A	W1	W3
	Prox sensors (2)	AS-i <sup>5</sup>	24V DC		Y1 (31 or 62)	Y3 (31 or 62)

DESCRIPTION	CONTROL TOP MODEL & POSITION INDICATION	COMMUNICATION CARD	VOLTAGE	NO CONTROL TOP
NO CONTROL TOP	No sensors	-	-	000
	No sensors, WCB Control top indicator stem			001
	No sensors, WCB Control top indicator stem - Set & Forget			001SF

DESCRIPTION	ACTUATOR OPTION & POSITION INDICATION	COMMUNICATION CARD	VOLTAGE	BRACKET MOUNT - NO CONTROL TOP <sup>1</sup>
NO CONTROL TOP	Set & Forget Only <sup>11</sup>	-	Dual Rated 24V DC / 110V AC	510
	Prox sensor (2)			540
	Prox Sensor (2) <sup>2</sup>		Intrinsically Safe 5-25V DC	600

<sup>1</sup> Where proximity sensors are indicated, these are externally mounted on top of actuators unless specified otherwise

<sup>2</sup> Requires amplifier (not included-provided by others)

<sup>5</sup> Append “(31)” or “(62)” for number of max nodes/slaves available on AS-i card

<sup>11</sup> Set & Forget sensor not available on W72 series valves

Consult factory for special control module requirements.

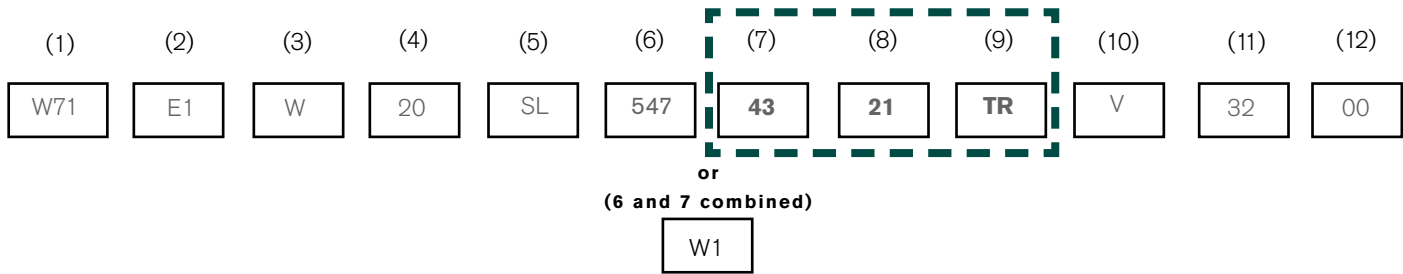

**(7) SOLENOID CONDITION**

VALVE	DESCRIPTION*	OPTION NUMBER
	No Option	00
W71, W73	Mix Proof - No Solenoid	20
	Mix Proof - 1 Solenoid	21
	Mix Proof - 2 Solenoids	22
	Mix Proof - 3 Solenoids	23
	Mix Proof Radial Seal (RS) - No Solenoid	30
W72RS	Mix Proof Radial Seal (RS) - 1 Solenoid	31
	Mix Proof Radial Seal (RS) - 2 Solenoid	32
	Mix Proof Radial Seal (RS) - 3 Solenoid	33

**Note: For Mix Proof Valves, Solenoid 1 = Valve Open, Solenoid 2 = Upper Seat Clean, Solenoid 3 = Lower Seat Clean**

**(8) CONTROL TOP CONNECTORS**

DESCRIPTION	OPTION NUMBER
No Connector	00
Strain Relief Connector	01
10 Pin Eurofast Connector	21
12 Pin Eurofast Connector	22
10cm Cord Set M12 12-Pin Eurofast <sup>2</sup>	22(10CM)
4 Pin Eurofast Connector	24
10cm Cord Set M12 4-Pin Eurofast-Asi <sup>2</sup>	24(ASI-10CM)
5 Pin Eurofast Connector	25
80cm Cord Set M12 5-Pin Eurofast-Dnet <sup>2</sup>	25(DNET-80CM)
6 Pin Eurofast Connector	26
8 Pin Eurofast Connector	28

**Includes connector on control module only, mating connector**

- 1. Available on maintenance-free actuator only
- 2. Available with 8681 control top only

**(9) SEAT**

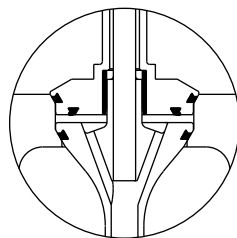

**TR - Tri Ring Compression**  
(W71/W73)

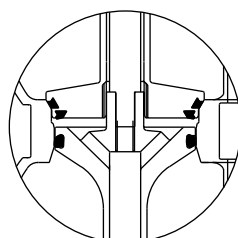

**TR - Tri Ring Radial Seal**  
(W72RS)

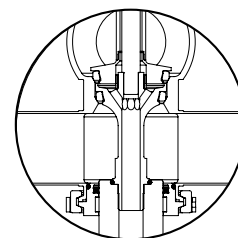

**Tef-Flow™ P**  
(W71/W73 Option)

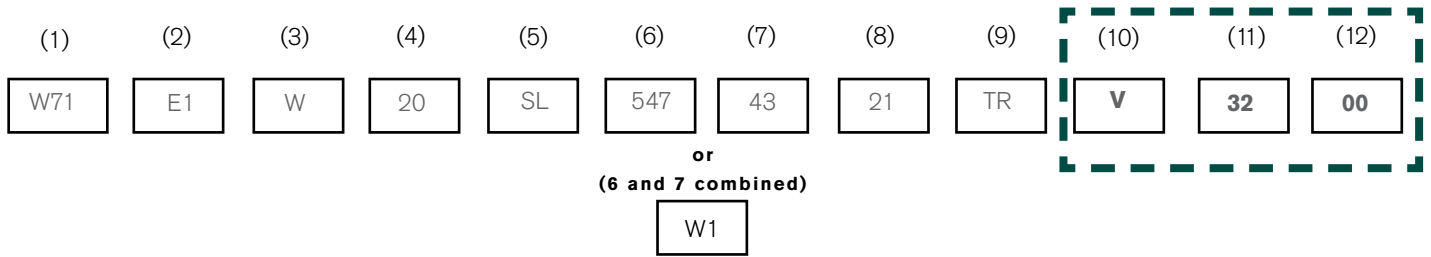

## (10) ELASTOMER

(Specifies materials for all gaskets, O-rings, & Tri Ring seals)

- E** EPDM
- V** Fluoroelastomer
- X** Optional Elastomer (specify)

Contact Factory for special requirements.

## (11) FINISH

- 32** Standard Finish (Machined <32Ra) ID (.8µm)
- 15** 15Ra Mechanical Polish ID (.2µm)

**Electropolish (EP) is in addition to the mechanical polish finish.**

## (12) OPTIONS

DESCRIPTION	OPTION NUMBER
No Options	00
Heat Certification / MTR's	06
SS Tags	08
Quick Dump Valve	09
Ext Flush (Liquid vent cavity only)	11
Quad Ring Upper and Lower	13
Paper Tags	18
1" (25 mm) Hose Barb Drain Connection	70

Multiple options available (Example: Stainless Steel Tags & External Liquid Flush: 08,11)

\*Steam continually accesses vent cavity when valve is open and closed.

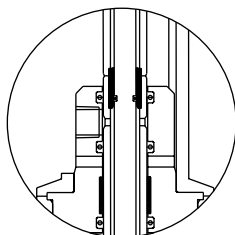

**External Flush  
Liquid Vent Cavity**

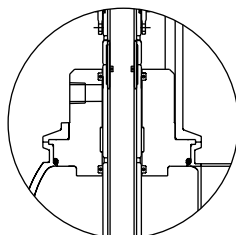

**External Flush  
Steam Vent Cavity  
Upper Stem**

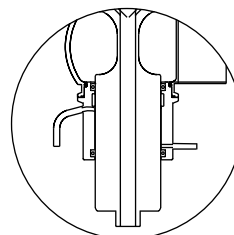

**External Flush  
Lower Stem  
(Liquid or Steam)**

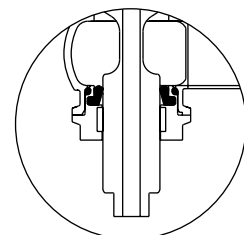

**Wiping Stem Seal  
(Lower Stem Shown)**

## D4 Series Double Seat Mix Proof Valves

The D4 Series is the next generation of mix proof valve technology resulting from the continued development of both the APV™ and Waukesha Cherry-Burrell™ brands. This global valve utilizes a slightly different valve key and part number structure than the traditional Waukesha Cherry-Burrell™ brand valves.

### D4 Series model range includes:

- D4 – primary, price-competitive model which meets basic mix proof needs for reliable separation, seat lift (SL) or non-seat lift (NSL) cleanability, and low product switching losses
- DA4 – ultra-hygienic model for critical applications requiring enhanced cleanability of product contact surfaces and low CIP losses to drain

The Valve Key is designed to provide our customers with a clear and concise description of the valve required. The key number should be an 11-digit number defining all areas of the valve's specification.

Example: D4 Mix Proof valve with a 44 style one piece body, butt-weld port connection, 3.0" size, seat lifting actuator, CU4 24V Direct Connect control unit, (2) sensors, and (3) solenoids, cable gland connector, 1/4" OD air fittings, elastomeric profile seat seals, EPDM seal material, 32 Ra inside surface finish, and no options.

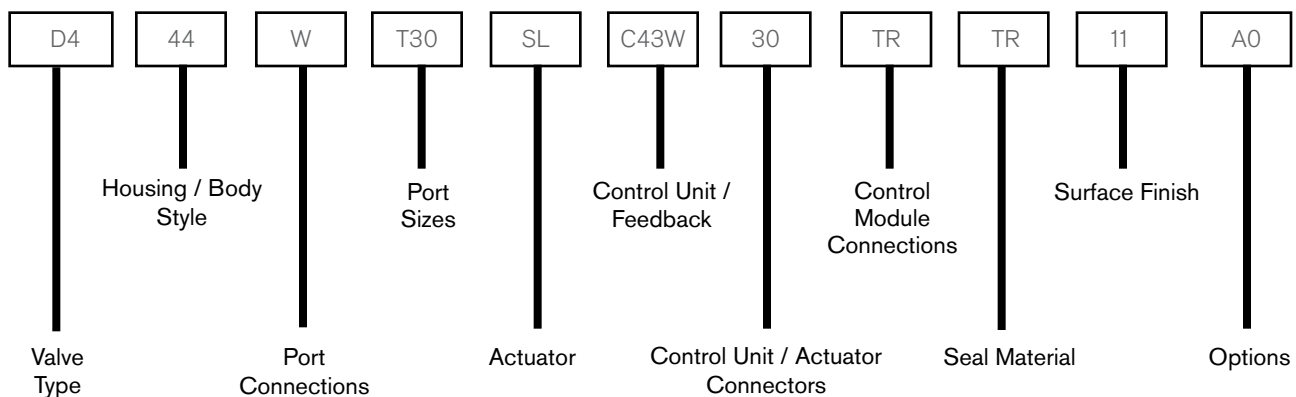



# D4 Series Double Seat Mix Proof Valves

## (1) VALVE TYPE

**D4** Double Seat Mix Proof

## (2) HOUSING COMBINATIONS

### Shut-off Valves



## (3) PORT CONNECTIONS

**W** Buttweld

**T** Clamp

Additional and mixed port connections available upon request. Please contact factory.

## (4) PORT SIZES

- T15** 1.5" Tube
- T20** 2.0" Tube      **P20** 2" IPS Schedule 5 Pipe
- T25** 2.5" Tube
- T30** 3.0" Tube      **P30** 3" IPS Schedule 5 Pipe
- T40** 4.0" Tube      **P40** 4" IPS Schedule 5 Pipe
- T60** 6.0" Tube      **P60** 6" IPS Schedule 5 Pipe

For mixed size valves, indicate lower ports first.  
**Example: 1.5" Lower Housing by 2" Upper Housing is T15T20.**  
 To verify availability of mixed sizes, please contact Factory

## (5) ACTUATOR

IDENTIFIER	DESCRIPTION
NSL	Non Seat Lifting
SL	Seat Lifting

## (6) CONTROL UNIT / FEEDBACK

See page 33 for most common control unit configurations. **BOLD** indicates standard control unit options. Use identifier "HP0N" as default for valves without control unit.

### CU Identifier Positions 1 & 2

CONTROL TOP TYPE	
<b>C4</b>	<b>CU4</b>
CP	CU4plus
BK	8681

### CU Identifier Position 3

SOLENOID	
1	1 Solenoid*
3	3 Solenoids

\*Not available with seat lift actuator

### CU Identifier Position 4

	COMMUNICATION TYPE		CU UNITS AVAILABLE
	COMMUNICATION	VOLTAGE	
<b>W</b>	<b>Direct Connect</b>	<b>24V DC</b>	<b>CU4, CU4plus, 8681</b>
<b>Y</b>	<b>AS-i 62</b>		<b>CU4, CU4plus, 8681</b>
<b>Z</b>	DeviceNET		8681
<b>S</b>	IO Link		CU4Plus

## (7) CONTROL UNIT / ACTUATOR CONNECTORS

1/4" AIR FITTINGS	ELECTRICAL CONNECTION
3X	No CU
<b>30</b>	<b>Cable Gland</b>
34	4-pin M12 Connector*
35	5-pin M12 Connector**
38	8-pin M12 Connector**
32	12-pin M12 Connector***

\*Available on CU with AS-i and IO Link Communication

\*\*Only available on CU4 with Direct Connect or with DeviceNET

\*\*\*Only available on 8681 with Direct Connect

## (8) SEAT TYPE

**TR** Elastomeric Profile Seal

## (9) SEAL MATERIAL

**E** EPDM

**V** FPM

## (10) SURFACE FINISH

GLASS BLASTED OD	INSIDE POLISH
11	32 μ-in (0.8 μm ) Ra ID

## (11) OPTIONS

**A0** None

**C1** Shaft flush

**NOTE: 3-A certified design is standard**



# D4 Series Double Seat Mix Proof Changeover Valve

## (1) VALVE TYPE

**D4** Double Seat Mix Proof

## (2) HOUSING COMBINATIONS

### Shut-off Valves

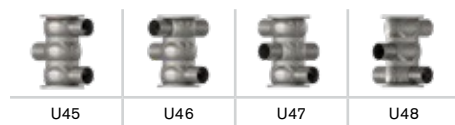

## (3) PORT CONNECTIONS

**W** Buttweld

**T** Clamp

Additional and mixed port connections available upon request. Please contact factory.

## (4) PORT SIZES

**T15** 1.5" Tube

**T20** 2.0" Tube

**T25** 2.5" Tube

**T30** 3.0" Tube

**T40** 4.0" Tube

## (5) ACTUATOR

IDENTIFIER	DESCRIPTION
SL	Seat Lifting

## (6) CONTROL UNIT / FEEDBACK

See page 33 for most common control unit configurations. **BOLD** indicates standard control unit options. Use identifier "HP0N" as default for valves without control unit.

### CU Identifier Positions 1 & 2

CONTROL TOP TYPE	
<b>C4</b>	<b>CU4</b>
CP	CU4plus
BK	8681

### CU Identifier Position 3

SOLENOID	
3	3 Solenoids

\*Not available with seat lift actuator

### CU Identifier Position 4

	COMMUNICATION TYPE		CU UNITS AVAILABLE
	COMMUNICATION	VOLTAGE	
<b>W</b>	<b>Direct Connect</b>	<b>24V DC</b>	<b>CU4, CU4 plus</b>
<b>Y</b>	<b>AS-i 62</b>		<b>CU4, CU4plus, 8681</b>
Z	DeviceNET		8681
S	IO Link		CU4Plus

## (7) CONTROL UNIT / ACTUATOR CONNECTORS

1/4" AIR FITTINGS	ELECTRICAL CONNECTION
3X	No CU
<b>30</b>	<b>Cable Gland</b>
34	4-pin M12 Connector*
35	5-pin M12 Connector**
38	8-pin M12 Connector**
32	12-pin M12 Connector***

\*Available on CU with AS-i and IO Link Communication

\*\*Only available on CU4 with Direct Connect or with DeviceNET

\*\*\*Only available on 8681 with Direct Connect

## (8) SEAT TYPE

**TR** Elastomeric Profile Seal

## (9) SEAL MATERIAL

**E** EPDM

**V** FPM

## (10) SURFACE FINISH

GLASS BLASTED OD	INSIDE POLISH
11	32 μ-in (0.8 μm ) Ra ID

## (11) OPTIONS

**A0** None

**NOTE: 3-A certified design is standard**

# DT4 Tank Outlet And DP4 Piggable Mix Proof Valve



Tank Outlet Piggable

The order code is constructed as follows:

POSITION	1	2	3	4	5	6	7	8	9	10	11*
CODE	DT4	T42	W	T25	SL	C43Y	34	TR	E	11	C1

## (1) VALVE TYPE

**DT4** Tank Outlet Mix Proof

**DP4** Piggable Mix Proof Valve

## (2) HOUSING COMBINATIONS

### Shut-off Valves

Tank Outlet	Piggable	
T42	DP42	DP44

## (3) PORT CONNECTIONS

**W** Buttweld

Additional port connections available upon request. Please contact factory.

## (4) PORT SIZES

**T15** 1.5" Tube

**T20** 2.0" Tube

**T25** 2.5" Tube

**T30** 3.0" Tube

**T40** 4.0" Tube

## (5) ACTUATOR

IDENTIFIER	DESCRIPTION
SL	Seat Lifting

## (6) CONTROL UNIT / FEEDBACK

See page 33 for most common control unit configurations. **BOLD** indicates standard control unit options. Use identifier "HP0N" as default for valves without control unit.

### CU Identifier Positions 1 & 2

CONTROL UNIT TYPE	
<b>C4</b>	<b>CU4</b>
CP	CU4plus

## CU Identifier Position 3

SOLENOID	
3	3 Solenoids

## CU Identifier Position 4

COMMUNICATION TYPE			CU UNITS AVAILABLE
	COMMUNICATION	VOLTAGE	
<b>W</b>	<b>Direct Connect</b>	<b>24V DC</b>	<b>CU4</b>
<b>Y</b>	<b>AS-i 62</b>		<b>CU4, CU4plus</b>
<b>S</b>	<b>IO Link</b>		<b>CU4plus</b>

## (7) CONTROL UNIT / ACTUATOR CONNECTORS

1/4" AIR FITTINGS	ELECTRICAL CONNECTION
3X	No CU
<b>30</b>	<b>Cable Gland</b>
34	4-pin M12 Connector*
38	8-pin M12 Connector**

\*Available on CU with AS-i and IO Link Communication

\*\*Only available on CU4 with Direct Connect

## (8) SEAT TYPE

**TR** Elastomeric Profile Seal

## (9) SEAL MATERIAL

**E** EPDM

**V** FPM

**H** HNBR

## (10) SURFACE FINISH

GLASS BLASTED OD	INSIDE POLISH
11	0.8 μm (32 μ-in) Ra ID

## (11) OPTIONS

**A0** None

**C1** Shaft flush

**NOTE:** Shaft flush and 3-A certified design as standard



# DA4 Series Double Seat Mix Proof Valves



## (1) VALVE TYPE

**DA4** Advanced Ultra-Hygienic Double Seat Mix Proof

## (2) HOUSING COMBINATIONS

### Shut-off Valves



## (3) PORT CONNECTIONS

**W** Buttweld

**T** Clamp

Additional and mixed port connections available upon request. Please contact factory.

## (4) PORT SIZES

**T15** 1.5" Tube

**T20** 2.0" Tube

**T25** 2.5" Tube

**T30** 3.0" Tube

**T40** 4.0" Tube

For mixed size valves, indicate lower ports first.

Example: 1.5" Lower Housing by 2" Upper Housing is **T15T20**.

To verify availability of mixed sizes, please contact Factory

## (5) ACTUATOR

IDENTIFIER	DESCRIPTION
SL	Seat Lifting (Includes Integrated Upper and Lower Shaft Flush for extensive cleaning and minimal CIP losses to drain)

## (6) CONTROL UNIT / FEEDBACK

See page 33 for most common control unit configurations. **BOLD** indicates standard control unit options. Use identifier "HP0N" as default for valves without control unit.

### CU Identifier Positions 1 & 2

CONTROL TOP TYPE	
<b>C4</b>	<b>CU4</b>
CP	CU4plus
BK	8681

### CU Identifier Position 3

SOLENOID	
3	3 Solenoids

### CU Identifier Position 4

	COMMUNICATION TYPE		CU UNITS AVAILABLE
	COMMUNICATION	VOLTAGE	
<b>W</b>	<b>Direct Connect</b>	<b>24V DC</b>	<b>CU4, CU4plus, 8681</b>
<b>Y</b>	<b>AS-i 62</b>		<b>CU4, CU4plus, 8681</b>
Z	DeviceNET		8681
S	IO Link		CU4plus

## (7) CONTROL UNIT / ACTUATOR CONNECTORS

1/4" AIR FITTINGS	ELECTRICAL CONNECTION
3X	No CU
<b>30</b>	<b>Cable Gland</b>
34	4-pin M12 Connector*
35	5-pin M12 Connector**
38	8-pin M12 Connector**

\*Available on CU with AS-i and IO Link Communication

\*\*Only available on CU4 Direct Connect Wire or 8681 with DeviceNET

## (8) SEAT TYPE

**TR** Elastomeric Profile Seal

## (9) SEAL MATERIAL

**E** EPDM

**V** FPM

## (10) SURFACE FINISH

GLASS BLASTED OD	INSIDE POLISH
11	32 μ-in (0.8 μm ) Ra ID

## (11) OPTIONS

**A0** None





# D4PMO Double Seat Mix Proof Valves

## (1) VALVE TYPE

**D4PMO** PMO Compliant Double Seat Mix Proof

## (2) HOUSING COMBINATIONS

### Shut-off Valves



## (3) PORT CONNECTIONS

**W** Buttweld

**T** Clamp

Additional and mixed port connections available upon request. Please contact factory.

## (4) PORT SIZES

**T15** 1.5" Tube

**T20** 2.0" Tube

**T25** 2.5" Tube

**T30** 3.0" Tube

**T40** 4.0" Tube

For mixed size valves, indicate lower ports first.  
Example: 1.5" Lower Housing by 2" Upper Housing is T15T20.  
To verify availability of mixed sizes, please contact factory.

## (5) ACTUATOR

IDENTIFIER	DESCRIPTION
SL	Seat Lifting (Includes Integrated Upper Shaft Flush for extensive cleaning during seat lift movement without external piping)

## (6) CONTROL UNIT / FEEDBACK

See page 33 for most common control unit configurations. **BOLD** indicates standard control unit options. Use identifier "HP0N" as default for valves without control unit.

### CU Identifier Positions 1 & 2

CONTROL TOP TYPE	
CP	<b>CU4plus</b>
BK	8681

### CU Identifier Position 3

SOLENOID	
3	3 Solenoids

### CU Identifier Position 4

	COMMUNICATION TYPE		CU UNITS AVAILABLE
	COMMUNICATION	VOLTAGE	
W	Direct Connect	24V DC	<b>CU4plus, 8681</b>
<b>Y</b>	<b>AS-i 62</b>		<b>CU4plus, 8681</b>
Z	DeviceNET		8681
S	IO Link		CU4plus

## (7) CONTROL UNIT / ACTUATOR CONNECTORS

1/4" AIR FITTINGS	ELECTRICAL CONNECTION
3X	No CU
<b>30</b>	<b>Cable Gland</b>
34	4-pin M12 Connector*
35	5-pin M12 Connector**
32	12-pin M12 Connector***

\*Available on CU with AS-i and IO Link Communication  
\*\*Only available on 8681 with DeviceNET  
\*\*\*Only available on 8681 with Direct Connect

## (8) SEAT TYPE

**TR** Elastomeric Profile Seal

## (9) SEAL MATERIAL

**E** EPDM

**V** FPM

## (10) SURFACE FINISH

GLASS BLASTED OD	INSIDE POLISH
11	32 μ-in (0.8 μm ) Ra ID

## (11) OPTIONS

**A0** None

# Control Units for D4 Series Valves



Control Units are identified with a 4 digit code.

IDENTIFIER POSITION	1 & 2	3	4
EXAMPLE CODE	C4	3	W
EXAMPLE VALVE KEY CODE	D4- 44- W- T30- SL- C43W- 30- TR- E- 11- A0		

## COMMON CONFIGURATIONS

CONTROL UNIT IDENTIFIER	CU TYPE	COMMUNICATION TYPE	SOLENOIDS	COMMON VALVE TYPE AVAILABLE
HP0N	Prox Holder Bracket	None	0 solenoids	D4NSL, D4SL, DT4, DA4, D4PMO
C41W	CU4	Direct Connect 24V DC	1 solenoids	D4NSL
C43W	CU4	Direct Connect 24V DC	3 solenoids	D4SL, DT4, DA4, DP4
C41Y	CU4	AS-i 62	1 solenoids	D4NSL
C43Y	CU4	AS-i 62	3 solenoids	D4SL, DT4, DA4, DP4
CP1W	CU4plus	Direct Connect 24V DC	1 solenoids	D4NSL
CP3W	CU4plus	Direct Connect 24V DC	3 solenoids	D4SL, DT4, DA4, D4PMO, DP4
CP1Y	CU4plus	AS-i 62	1 solenoids	D4NSL
CP3Y	CU4plus	AS-i 62	3 solenoids	D4SL, DT4, DA4, D4PMO, DP4
CX1W	ATEX / IECEx CU	Direct Connect 24 V DC	1 solenoids	D4
CP1S	CU4plus	IO Link	1 solenoids	D4NSL
CP3S	CU4plus	IO Link	3 solenoids	D4SL, DT4, DA4, D4PMO
CX3W	ATEX / IECEx CU	Direct Connect 24 V DC	3 solenoids	D4, DA
BK1W	8681	24V DC	1 solenoids	D4NSL
BK3W	8681	24V DC	3 solenoids	D4SL, DT4, DA4, D4PMO
BK1Y	8681	AS-i 62	1 solenoids	D4NSL
BK3Y	8681	AS-i 62	3 solenoids	D4SL, DT4, DA4, D4PMO
BK1Z	8681	DeviceNET	1 solenoids	D4NSL
BK3Z	8681	DeviceNET	3 solenoids	D4SL, DT4, DA4, D4PMO

CONTROL UNIT TYPE	DESCRIPTION
C4	CU4 model with 2 Hall sensors for feedback
CP	CU4plus model with Teach-in/Linear sensor for feedback and SLD
BK	Burkert brand 8681 model with Teach-in/Linear sensor for feedback, SLD, M12 pin connector as standard

**SLD = Seat Lift Detection for Mix Proof Valves**



# ➤ Waukesha Cherry-Burrell®

**SPXFLOW®**

**SPX FLOW, Inc.**

611 Sugar Creek Road  
Delavan, WI 53115  
P: (262) 728-1900 or (800) 252-5200  
E: [wcb@spxflow.com](mailto:wcb@spxflow.com)

Based in Charlotte, North Carolina, SPX FLOW, Inc. (NYSE: FLOW) is a multi-industry manufacturing leader. For more information, please visit [www.spxflow.com](http://www.spxflow.com)

SPX FLOW, Inc. reserves the right to incorporate our latest design and material changes without notice or obligation.

Design features, materials of construction, dimensional data and certifications as described in this bulletin, are provided for your information only and should not be relied upon unless confirmed in writing. Please contact your local sales representative for product availability in your region. For more information visit [www.spxflow.com](http://www.spxflow.com).

The green "➤" and "x" are trademarks of SPX FLOW, Inc.

WCB-Valves-Key-VK-1000-DST-US  
Identification Number: VK-1000-US

Update: 08/2022

COPYRIGHT © 2021, 2022 SPX FLOW, Inc.